



TRIPLASSA
desde 1966

MULTIPLÁSTICOS INYECTADOS S.L.





TUBOS

LISOS



TRIPLASSA
desde 1966

MULTIPLÁSTICOS
INYECTADOS S.L.

MEDIDAS / MEASURES / LES MESURES

LONGITUD / LENGTH / LONGEUR:	196 mm
Ø INTERIOR PUNTA/ INSIDE TIP / POINTE INTÉRIEURE:	43 mm
Ø INTERIOR BASE / INNER BASE/ FOND INTERIEUR:	43 mm
ESPESOR / THICKNESS / ÉPAISSEUR:	2.5 mm
PESO / WEIGHT / POIDS:	67 g

DESCRIPCIÓN: Tubo liso.
MATERIAL: Polipropileno.

DESCRIPTION: Smooth tube.
MATERIAL: Polypropylene.

LA DESCRIPTION: Tube lisse.
MATÉRIEL: Polypropylène.

TUBO LISO
SMOOTH TUBE
TUBE LISSE

PUNTA DEL TUBO
Ø I.P 43 mm



BASE DEL TUBO
Ø I.B 43 mm



PUNTA



LONGITUD
196 mm

BASE

COLORES REPRESENTATIVOS

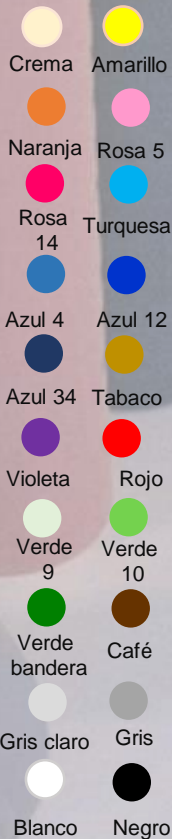

MEDIDAS / MEASURES / LES MESURES

LONGITUD / LENGTH / LONGEUR:	225 mm
Ø INTERIOR PUNTA / INSIDE TIP / POINTE INTÉRIEURE:	43 mm
Ø INTERIOR BASE / INNER BASE / FOND INTERIEUR:	43 mm
ESPESOR / THICKNESS / ÉPAISSEUR:	2.5 mm
PESO / WEIGHT / POIDS:	76 g

DESCRIPCIÓN: Tubo liso.
MATERIAL: Polipropileno.

DESCRIPTION: Smooth tube.
MATERIAL: Polypropylene.

LA DESCRIPTION: Tube lisse.
MATÉRIEL: Polypropylène.

TUBO LISO
SMOOTH TUBE
TUBE LISSE

PUNTA DEL TUBO
Ø I.P 43 mm



BASE DEL TUBO
Ø I.B 43 mm

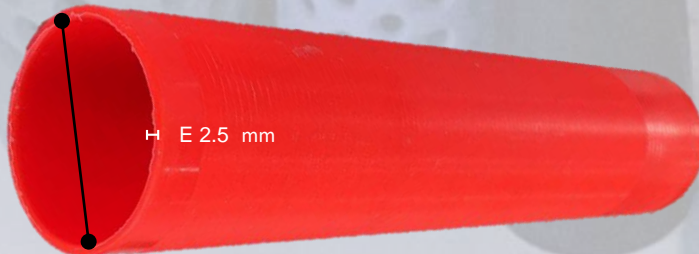

PUNTA



LONGITUD
225 mm

BASE

COLORES REPRESENTATIVOS



MEDIDAS / MEASURES / LES MESURES

LONGITUD / LENGTH / LONGEUR:	230 mm
Ø INTERIOR PUNTA/ INSIDE TIP / POINTE INTÉRIEURE:	56 mm
Ø INTERIOR BASE / INNER BASE/ FOND INTERIEUR:	56 mm
ESPESOR / THICKNESS / ÉPAISSEUR:	2.5 mm
PESO / WEIGHT / POIDS:	96 g

DESCRIPCIÓN: Tubo liso.
MATERIAL: Polipropileno.

DESCRIPTION: Smooth tube.
MATERIAL: Polypropylene.

LA DESCRIPTION: Tube lisse.
MATÉRIEL: Polypropylène .

TUBO LISO
SMOOTH TUBE
TUBE LISSE

PUNTA DEL TUBO

Ø I.P 56 mm



BASE DEL TUBO

Ø I.B 56 mm



PUNTA



LONGITUD
230 mm

BASE

COLORES REPRESENTATIVOS

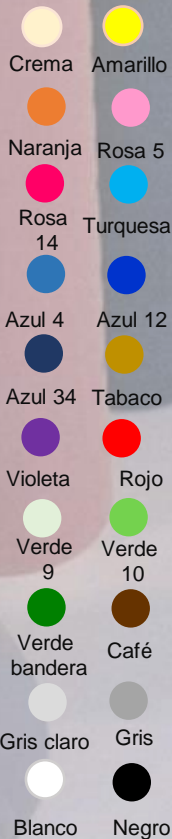

MEDIDAS / MEASURES / LES MESURES

LONGITUD / LENGTH / LONGEUR:	230 mm
Ø INTERIOR PUNTA/ INSIDE TIP / POINTE INTÉRIEURE:	45 mm
Ø INTERIOR BASE / INNER BASE/ FOND INTERIEUR:	56 mm
ESPESOR / THICKNESS / ÉPAISSEUR:	1.8 mm
PESO / WEIGHT / POIDS:	60 g

DESCRIPCIÓN: Tubo liso.
MATERIAL: Polipropileno.

DESCRIPTION: Smooth tube.
MATERIAL: Polypropylene.

LA DESCRIPTION: Tube lisse.
MATÉRIEL: Polypropylène .

TUBO LISO
SMOOTH TUBE
TUBE LISSE

PUNTA DEL TUBO
Ø I.P 45 mm



BASE DEL TUBO
Ø I.B 56 mm

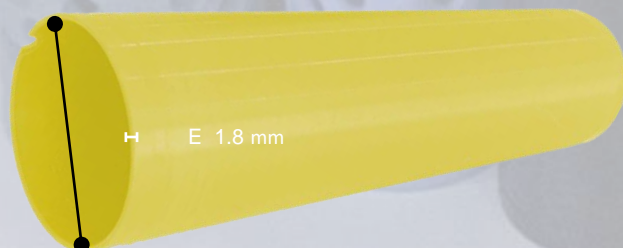

PUNTA



LONGITUD
230 mm

BASE

COLORES REPRESENTATIVOS



MEDIDAS / MEASURES / LES MESURES

LONGITUD / LENGTH / LONGEUR:	290 mm
Ø INTERIOR PUNTA / INSIDE TIP / POINTE INTÉRIEURE:	56 mm
Ø INTERIOR BASE / INNER BASE / FOND INTÉRIEUR:	56 mm
ESPESOR / THICKNESS / ÉPAISSEUR:	2 mm
PESO / WEIGHT / POIDS:	92 g

DESCRIPCIÓN: Tubo liso.
MATERIAL: Polipropileno.

DESCRIPTION: Smooth tube.
MATERIAL: Polypropylene.

LA DESCRIPTION: Tube lisse.
MATÉRIEL: Polypropylène.

TUBO LISO
SMOOTH TUBE
TUBE LISSE

PUNTA DEL TUBO
Ø I.P 56 mm

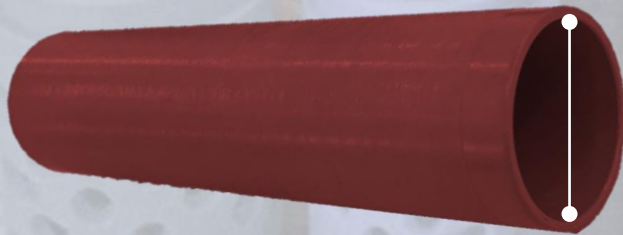

BASE DEL TUBO
Ø I.B 56 mm

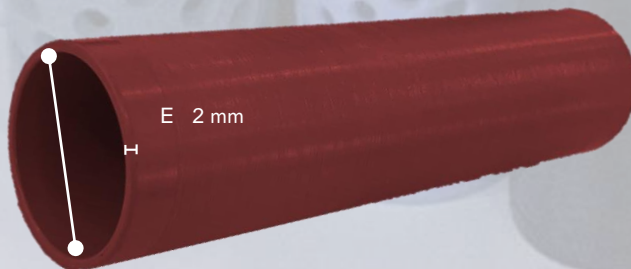

PUNTA



LONGITUD
290 mm

BASE

COLORES REPRESENTATIVOS

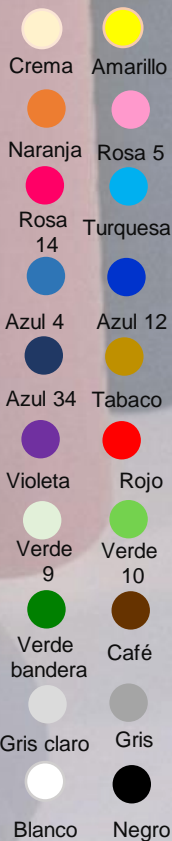

MEDIDAS / MEASURES / LES MESURES

LONGITUD / LENGTH / LONGEUR:	270 mm
Ø INTERIOR PUNTA/ INSIDE TIP / POINTE INTÉRIEURE:	56 mm
Ø INTERIOR BASE / INNER BASE/ FOND INTERIEUR:	56 mm
ESPESOR / THICKNESS / ÉPAISSEUR:	2 mm
PESO / WEIGHT / POIDS:	86 g

DESCRIPCIÓN: Tubo liso.
MATERIAL: Polipropileno.

DESCRIPTION: Smooth tube.
MATERIAL: Polypropylene.

LA DESCRIPTION: Tube lisse.
MATÉRIEL: Polypropylène.

TUBO LISO
SMOOTH TUBE
TUBE LISSE

PUNTA DEL TUBO
Ø I.P 56 mm

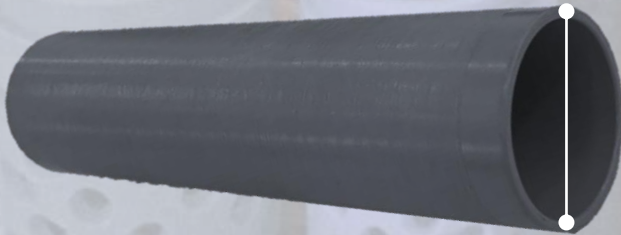

BASE DEL TUBO
Ø I.B 56 mm

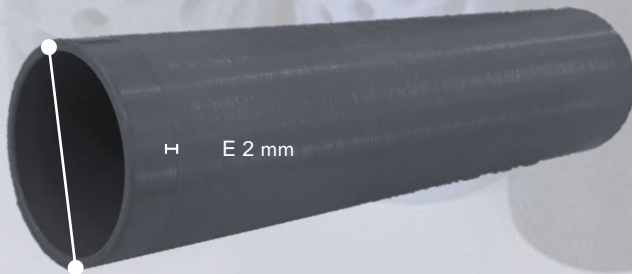

PUNTA



LONGITUD
270 mm

BASE

COLORES REPRESENTATIVOS

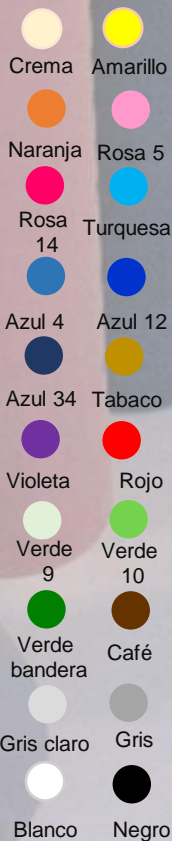



TUBOS

PERFORADOS



TRIPLASSA
desde 1966

MULTIPLÁSTICOS
INYECTADOS S.L.

REF. 65

TUBO PERFORADO

MEDIDAS / MEASURES / LES MESURES

LONGITUD / LENGTH / LONGEUR:	197 mm
Ø INTERIOR PUNTA / INSIDE TIP / POINTE INTÉRIEURE:	35 mm
Ø INTERIOR BASE / INNER BASE / FOND INTÉRIEUR:	44.5 mm
ESPESOR / THICKNESS / ÉPAISSEUR:	2 mm
PESO / WEIGHT / POIDS:	42 g

DESCRIPCIÓN: Tubo perforado.
MATERIAL: Polipropileno.

DESCRIPTION: Perforated tube.
MATERIAL: Polypropylene.

LA DESCRIPTION: Tube perforé.
MATÉRIEL: Polypropylène.

TUBO PERFORADO
PERFORATED TUBE
TUBE PERFORÉ

PUNTA DEL TUBO
Ø I.P 35 mm



BASE DEL TUBO
Ø I.B 44.5 mm

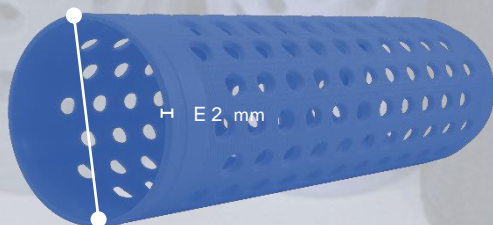

PUNTA



LONGITUD
197 mm

BASE

COLORES REPRESENTATIVOS

Crema	Amarillo
Naranja	Rosa 5
Rosa 14	Turquesa
Azul 4	Azul 12
Azul 34	Tabaco
Violeta	Rojo
Verde 9	Verde 10
Verde bandera	Café
Gris claro	Gris
Blanco	Negro



MEDIDAS / MEASURES / LES MESURES

LONGITUD / LENGTH / LONGEUR:	170 mm
Ø INTERIOR PUNTA / INSIDE TIP / POINTE INTÉRIEURE:	28 mm
Ø INTERIOR BASE / INNER BASE / FOND INTERIEUR:	36 mm
ESPESOR / THICKNESS / ÉPAISSEUR:	2 mm
PESO / WEIGHT / POIDS:	25 g

DESCRIPCIÓN: Tubo perforado.
MATERIAL: Polipropileno.

DESCRIPTION: Perforated tube.
MATERIAL: Polypropylene.

LA DESCRIPTION: Tube perforé.
MATÉRIEL: Polypropylène.

TUBO PERFORADO
PERFORATED TUBE
TUBE PERFORÉ

PUNTA DEL TUBO
Ø I.P 28 mm



BASE DEL TUBO
Ø I.B 36 mm

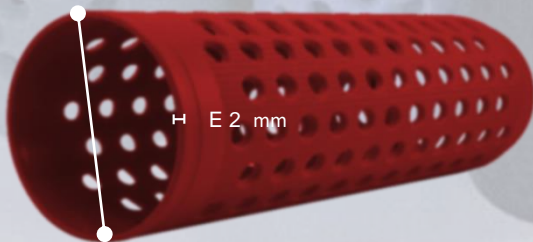

PUNTA



LONGITUD
170 mm

BASE

COLORES REPRESENTATIVOS



REF. 75.1

TUBO PERFORADO

MEDIDAS / MEASURES / LES MESURES

LONGITUD / LENGTH / LONGEUR:	230 mm
Ø INTERIOR PUNTA / INSIDE TIP / POINTE INTÉRIEURE:	45 mm
Ø INTERIOR BASE / INNER BASE / FOND INTERIEUR:	56 mm
ESPESOR / THICKNESS / ÉPAISSEUR:	3 mm
PESO / WEIGHT / POIDS:	67 g

DESCRIPCIÓN: Tubo perforado.
MATERIAL: Polipropileno.

DESCRIPTION: Perforated tube.
MATERIAL: Polypropylene.

LA DESCRIPTION: Tube perforé.
MATÉRIEL: Polypropylène.

TUBO PERFORADO
PERFORATED TUBE
TUBE PERFORÉ

PUNTA DEL TUBO
Ø I.P 45 mm

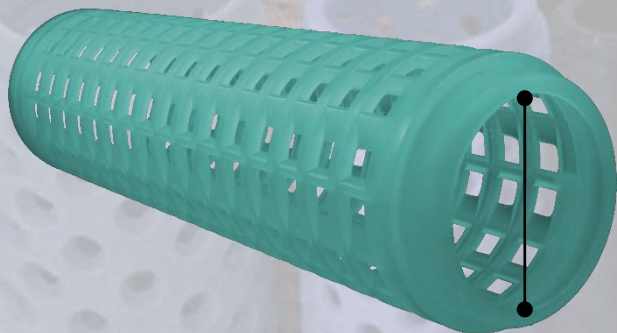

BASE DEL TUBO
Ø I.B 56 mm

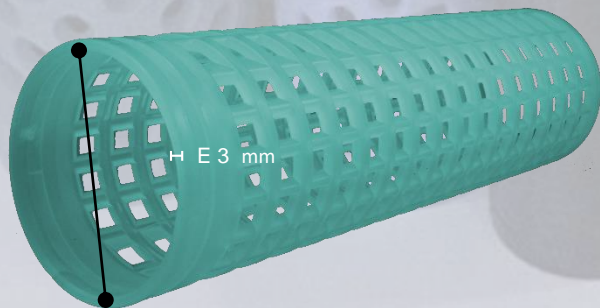

PUNTA

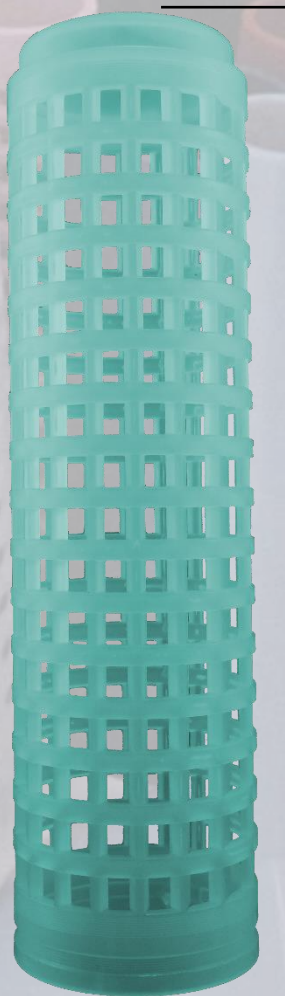

LONGITUD
230 mm

BASE

COLORES REPRESENTATIVOS



MEDIDAS / MEASURES / LES MESURES

LONGITUD / LENGTH / LONGEUR:	170 mm
Ø INTERIOR PUNTA / INSIDE TIP / POINTE INTÉRIEURE:	59 mm
Ø INTERIOR BASE / INNER BASE / FOND INTERIEUR:	54 mm
ESPESOR / THICKNESS / ÉPAISSEUR:	4.5 mm
PESO / WEIGHT / POIDS:	88 g

DESCRIPCIÓN: Tubo perforado.
MATERIAL: Polipropileno.

DESCRIPTION: Perforated tube.
MATERIAL: Polypropylene.

LA DESCRIPTION: Tube perforé.
MATÉRIEL: Polypropylène.

TUBO PERFORADO
PERFORATED TUBE
TUBE PERFORÉ

PUNTA DEL TUBO

Ø I.P 59 mm

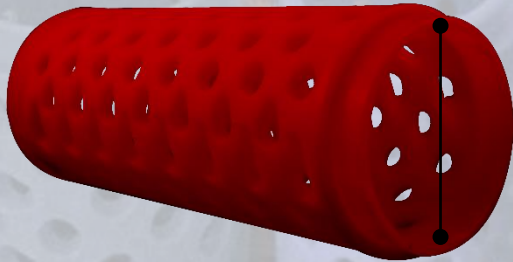

BASE DEL TUBO

Ø I.B 54 mm

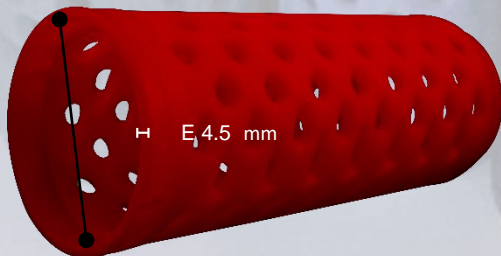

PUNTA

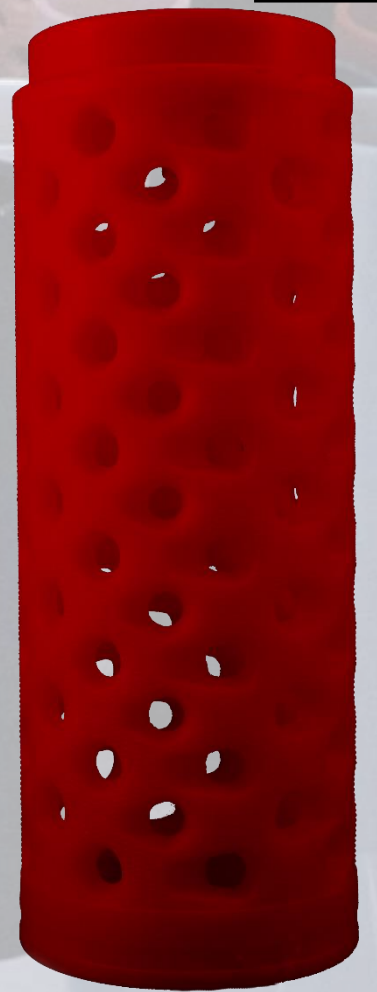

LONGITUD
170 mm

COLORES REPRESENTATIVOS

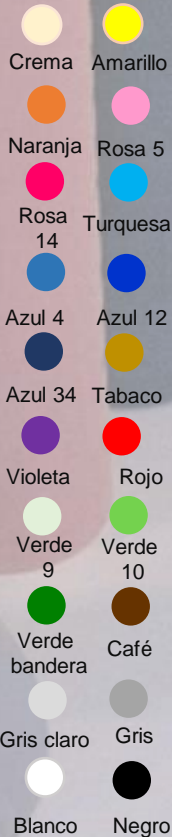

MEDIDAS / MEASURES / LES MESURES

LONGITUD / LENGTH / LONGEUR:	170 mm
Ø INTERIOR PUNTA / INSIDE TIP / POINTE INTÉRIEURE:	54 mm
Ø INTERIOR BASE / INNER BASE / FOND INTERIEUR:	54 mm
ESPESOR / THICKNESS / ÉPAISSEUR:	3 mm
PESO / WEIGHT / POIDS:	61 g

DESCRIPCIÓN: Tubo perforado.
MATERIAL: Polipropileno.

DESCRIPTION: Perforated tube.
MATERIAL: Polypropylene.

LA DESCRIPTION: Tube perforé.
MATÉRIEL: Polypropylène.

TUBO PERFORADO
PERFORATED TUBE
TUBE PERFORÉ

PUNTA DEL TUBO
Ø I.P 54 mm

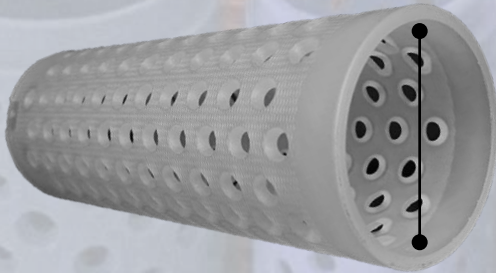

BASE DEL TUBO
Ø I.B 54 mm

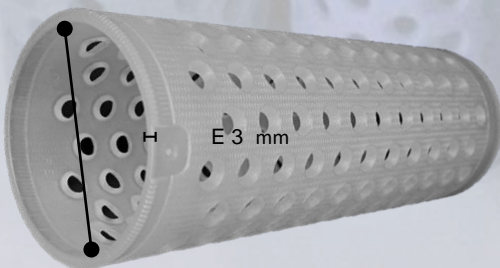

PUNTA

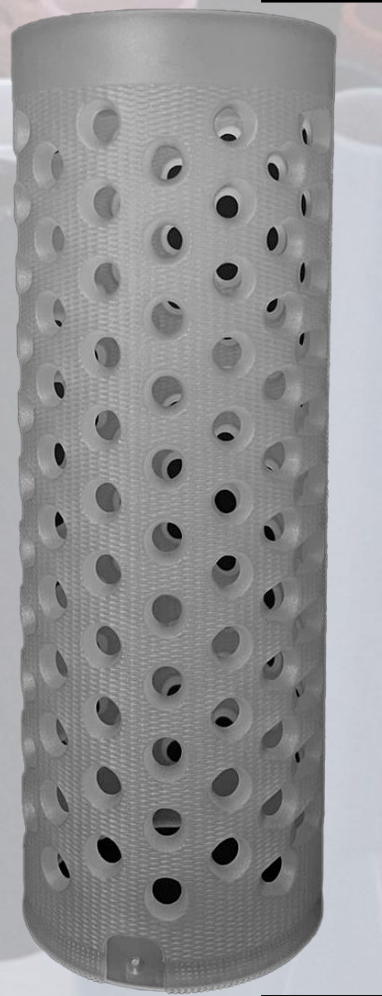

LONGITUD
170 mm

BASE

COLORES REPRESENTATIVOS



MEDIDAS / MEASURES / LES MESURES

LONGITUD / LENGTH / LONGEUR:	170 mm
Ø INTERIOR PUNTA / INSIDE TIP / POINTE INTÉRIEURE:	54 mm
Ø INTERIOR BASE / INNER BASE / FOND INTÉRIEUR:	59 mm
ESPESOR / THICKNESS / ÉPAISSEUR:	2 mm
PESO / WEIGHT / POIDS:	47 g

DESCRIPCIÓN: Tubo perforado.
MATERIAL: Polipropileno.

DESCRIPTION: Perforated tube.
MATERIAL: Polypropylene.

LA DESCRIPTION: Tube perforé.
MATÉRIEL: Polypropylène.

TUBO PERFORADO
PERFORATED TUBE
TUBE PERFORÉ

PUNTA DEL TUBO
Ø I.P 54 mm

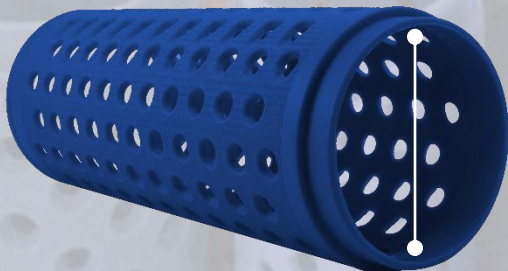

BASE DEL TUBO
Ø I.B 59 mm

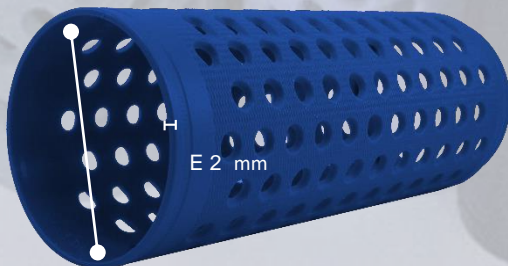

PUNTA

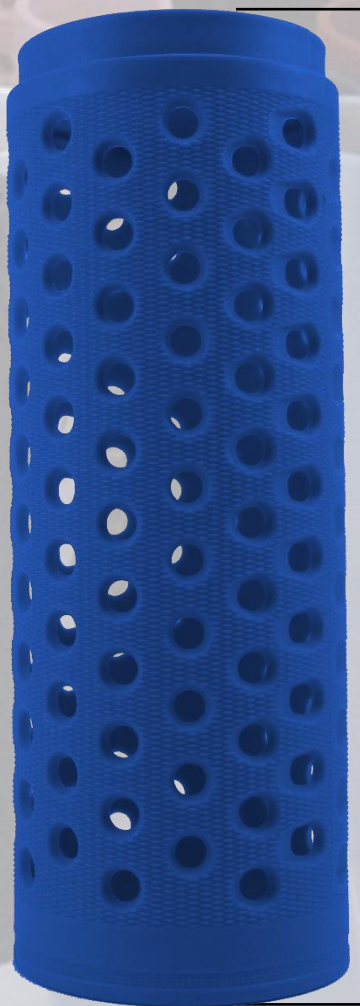

LONGITUD
170 mm

BASE

COLORES REPRESENTATIVOS



MEDIDAS / MEASURES / LES MESURES

LONGITUD / LENGTH / LONGEUR:	170 mm
Ø INTERIOR PUNTA / INSIDE TIP / POINTE INTÉRIEURE:	59 mm
Ø INTERIOR BASE / INNER BASE / FOND INTERIEUR:	54 mm
ESPESOR / THICKNESS / ÉPAISSEUR:	3.5 mm
PESO / WEIGHT / POIDS:	40 g

DESCRIPCIÓN: Tubo perforado.
MATERIAL: Polipropileno.

DESCRIPTION: Perforated tube.
MATERIAL: Polypropylene.

LA DESCRIPTION: Tube perforé.
MATÉRIEL: Polypropylène.

TUBO PERFORADO
PERFORATED TUBE
TUBE PERFORÉ

PUNTA DEL TUBO

Ø I.P 54 mm

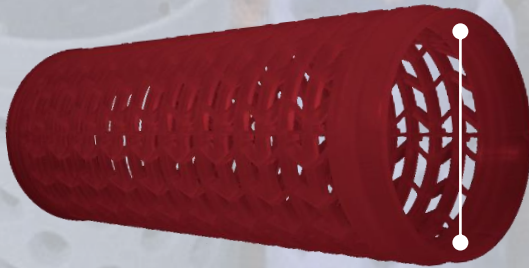

BASE DEL TUBO

Ø I.B 59 mm

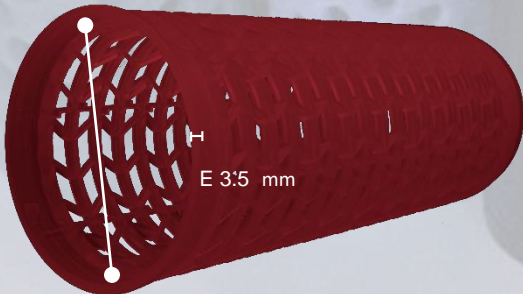

E 3.5 mm

PUNTA

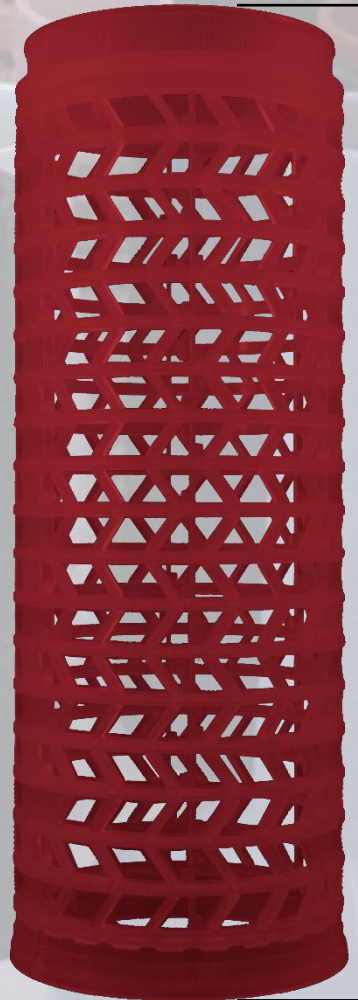

LONGITUD
170 mm

BASE

COLORES REPRESENTATIVOS

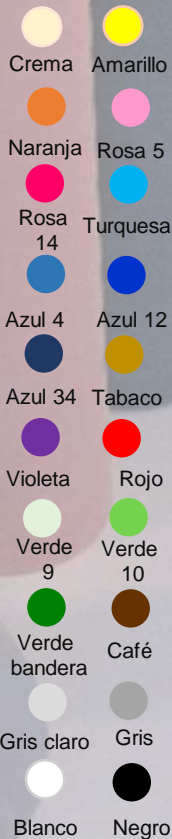

MEDIDAS / MEASURES / LES MESURES

LONGITUD / LENGTH / LONGEUR:	230 mm
Ø INTERIOR PUNTA / INSIDE TIP / POINTE INTÉRIEURE:	45 mm
Ø INTERIOR BASE / INNER BASE / FOND INTÉRIEUR:	56 mm
ESPESOR / THICKNESS / ÉPAISSEUR:	3 mm
PESO / WEIGHT / POIDS:	67 g

DESCRIPCIÓN: Tubo perforado

Deformación Radial .

MATERIAL: Polipropileno.

DESCRIPTION: Perforated tube.

MATERIAL: Polypropylene.

LA DESCRIPTION: Tube perforé.

MATÉRIEL: Polypropylène .

TUBO PERFORADO
PERFORATED TUBE
TUBE PERFORÉ

PUNTA

PUNTA DEL TUBO

Ø I.P 45 mm

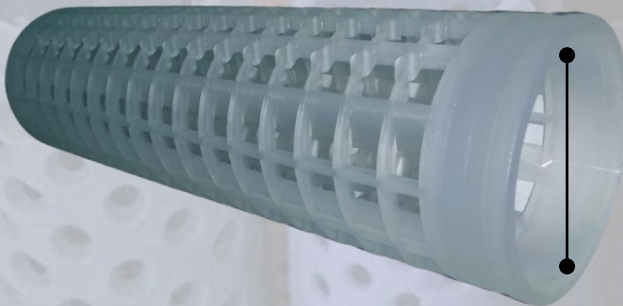

BASE DEL TUBO

Ø I.B 56 mm

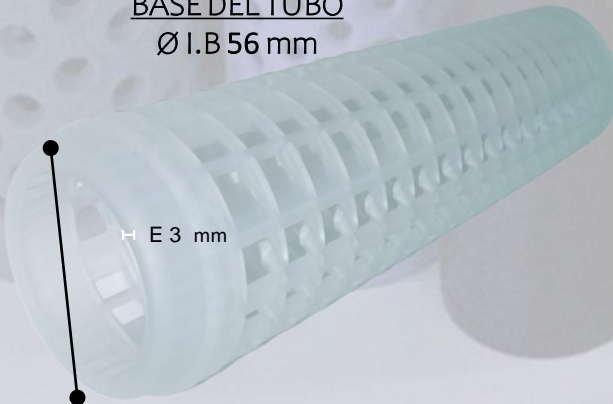

H E 3 mm

BASE

LONGITUD
230 mm

COLORES
REPRESENTATIVOS

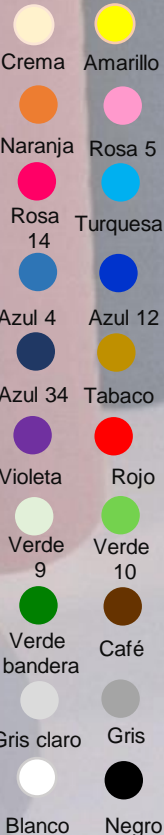

MEDIDAS / MEASURES / LES MESURES

LONGITUD / LENGTH / LONGEUR:	230 mm
Ø INTERIOR PUNTA / INSIDE TIP / POINTE INTÉRIEURE:	57 mm
Ø INTERIOR BASE / INNER BASE / FOND INTERIEUR:	69 mm
ESPESOR / THICKNESS / ÉPAISSEUR:	3 mm
PESO / WEIGHT / POIDS:	90 g

DESCRIPCIÓN: Tubo perforado.
MATERIAL: Polipropileno.

DESCRIPTION: Perforated tube.
MATERIAL: Polypropylene.

LA DESCRIPTION: Tube perforé.
MATÉRIEL: Polypropylène.

TUBO PERFORADO
PERFORATED TUBE
TUBE PERFORÉ

PUNTA DEL TUBO
Ø I.P 57 mm

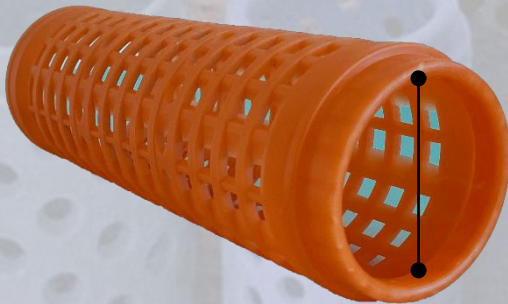

BASE DEL TUBO
Ø I.B 69 mm

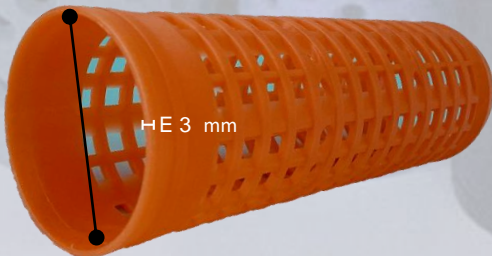

PUNTA

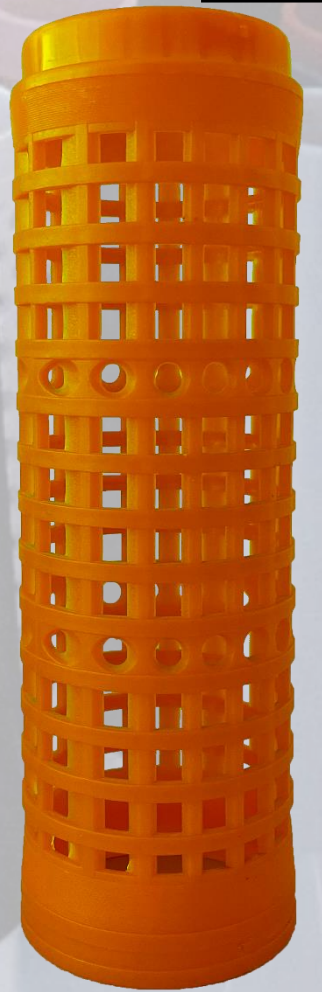

LONGITUD
230 mm

BASE

COLORES REPRESENTATIVOS



MEDIDAS / MEASURES / LES MESURES

LONGITUD / LENGTH / LONGEUR:	288 mm
Ø INTERIOR PUNTA / INSIDE TIP / POINTE INTÉRIEURE:	57 mm
Ø INTERIOR BASE / INNER BASE / FOND INTÉRIEUR:	69 mm
ESPESOR / THICKNESS / ÉPAISSEUR:	3 mm
PESO / WEIGHT / POIDS:	113 g

DESCRIPCIÓN: Tubo perforado.
MATERIAL: Polipropileno.

DESCRIPTION: Perforated tube.
MATERIAL: Polypropylene.

LA DESCRIPTION: Tube perforé.
MATÉRIEL: Polypropylène.

TUBO PERFORADO
PERFORATED TUBE
TUBE PERFORÉ

PUNTA DEL TUBO
Ø I.P 57 mm



BASE DEL TUBO
Ø I.B 69 mm

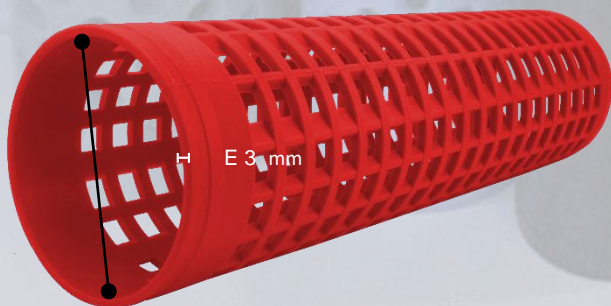

PUNTA

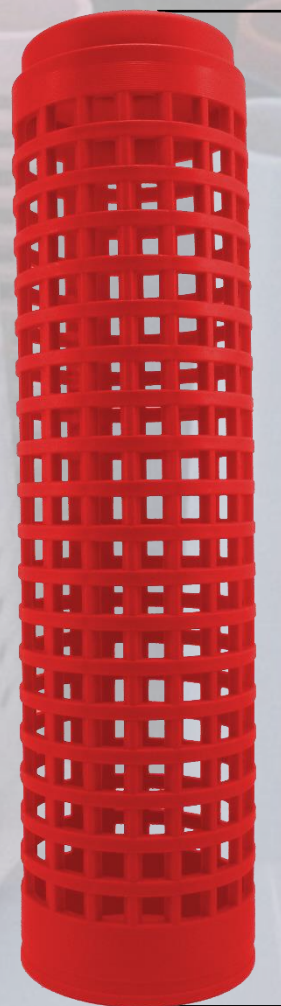

LONGITUD
288 mm

BASE

COLORES REPRESENTATIVOS



CONOS

LISOS



TRIPLASSA
desde 1966

MULTIPLÁSTICOS
INYECTADOS S.L.

MEDIDAS / MEASURES / LES MESURES

CONICIDAD/ CONICITY/ CONICITÉ:	3° 30
LONGITUD/ LENGTH/ LONGEUR:	175 mm
Ø INTERIOR PUNTA/ INSIDE TIP/ POINTE INTÉRIEURE:	39 mm
Ø INTERIOR BASE / INNER BASE/ FOND INTERIEUR:	59 mm
ESPESOR / THICKNESS / ÉPAISSEUR:	1.5 mm
PESO/ WEIGHT / POIDS:	31 g

DESCRIPCIÓN: Cono liso.
MATERIAL: Polipropileno.

DESCRIPTION: Smooth cone.
MATERIAL: Polypropylene.

LA DESCRIPTION: Cone lisse.
MATÉRIEL: Polypropylène .

CONO LISO
SMOOTH CONE
CONE LISSE

PUNTA DEL CONO
Ø I.P 39 mm

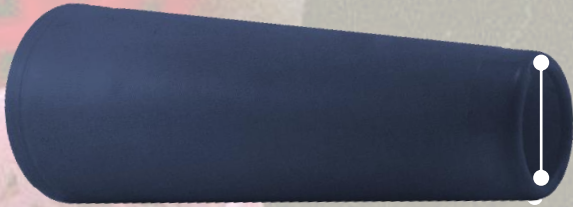

BASE DEL CONO
Ø I.B 59 mm

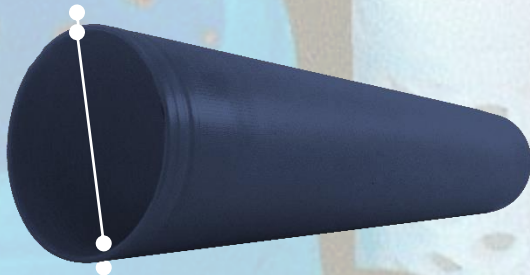

PUNTA



LONGITUD
175 mm

COLORES REPRESENTATIVOS





TRIPLASSA
desde 1966

MULTIPLÁSTICOS
INYECTADOS S.L.

REF. 3002

CONO 3° 30 LISO

MEDIDAS / MEASURES / LES MESURES

CONICIDAD/ CONICITY/ CONICITÉ:	3° 30
LONGITUD/ LENGTH/ LONGEUR:	230 mm
Ø INTERIOR PUNTA/ INSIDE TIP/ POINTE INTÉRIEURE:	25 mm
Ø INTERIOR BASE / INNER BASE/ FOND INTERIEUR:	62 mm
ESPESOR / THICKNESS / ÉPAISSEUR:	2 mm
PESO/ WEIGHT / POIDS:	57 g

DESCRIPCIÓN: Cono liso.
MATERIAL: Polipropileno.

DESCRIPTION: Smooth cone.
MATERIAL: Polypropylene.

LA DESCRIPTION: Cone lisse.
MATÉRIEL: Polypropylène .

CONO LISO
SMOOTH CONE
CONE LISSE

PUNTA DEL CONO

Ø I.P 25 mm

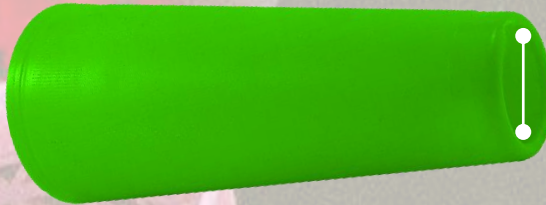

BASE DEL CONO

Ø I.B 62 mm

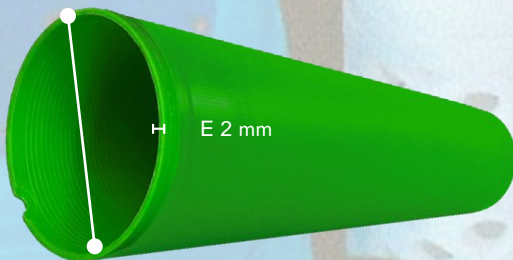

PUNTA



LONGITUD
230 mm

BASE

COLORES
REPRESENTATIVOS

- Crema
- Amarillo
- Naranja
- Rosa 5
- Rosa 14
- Turquesa
- Azul 4
- Azul 12
- Azul 34
- Tabaco
- Violeta
- Rojo
- Verde 9
- Verde 10
- Verde bandera
- Café
- Gris claro
- Gris
- Blanco
- Negro



La Mambra d'Oris. Ctra. C-17, km. 78, 08573 ORIS (Barcelona-Spain)



Tel. +34 93 859 26 61 / 62 607 26 95



E- mail: comercial@multiplasticos.es



MEDIDAS / MEASURES / LES MESURES

CONICIDAD/ CONICITY/ CONICITÉ:	3° 30
LONGITUD/ LENGTH/ LONGEUR:	280 mm
Ø INTERIOR PUNTA/ INSIDE TIP/ POINTE INTÉRIEURE:	22 mm
Ø INTERIOR BASE / INNER BASE/ FOND INTERIEUR:	64 mm
ESPESOR / THICKNESS / ÉPAISSEUR:	2 mm
PESO/ WEIGHT / POIDS:	66 g

DESCRIPCIÓN: Cono liso.
MATERIAL: Polipropileno.

DESCRIPTION: Smooth cone.
MATERIAL: Polypropylene.

LA DESCRIPTION: Cone lisse.
MATÉRIEL: Polypropylène.

CONO LISO
SMOOTH CONE
CONE LISSE

PUNTA DEL CONO
Ø I.P 22 mm

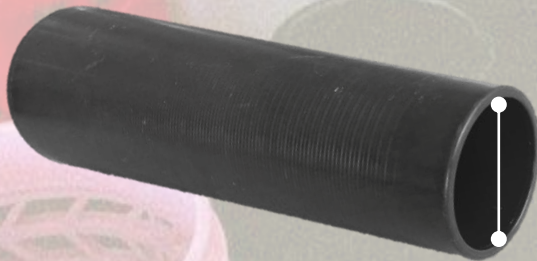

BASE DEL CONO
Ø I.B 64 mm

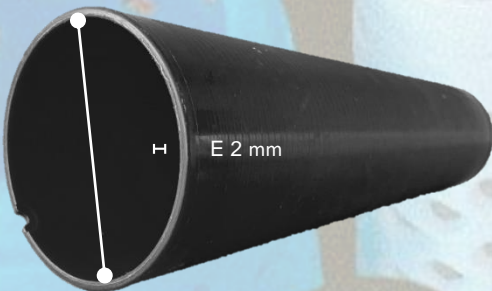

PUNTA

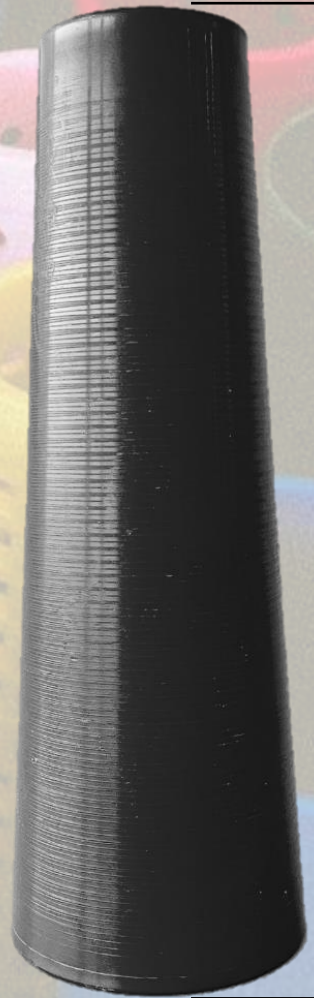

LONGITUD
280 mm

BASE

COLORES REPRESENTATIVOS

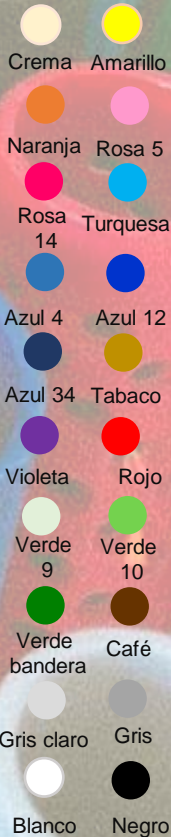



TRIPLASSA
desde 1966

MULTIPLÁSTICOS
INYECTADOS S.L.

REF. 3009

CONO 3° 30 LISO

MEDIDAS / MEASURES / LES MESURES

CONICIDAD/ CONICITY/ CONICITÉ:	3° 30
LONGITUD/ LENGTH/ LONGEUR:	272 mm
Ø INTERIOR PUNTA/ INSIDE TIP/ POINTE INTÉRIEURE:	46 mm
Ø INTERIOR BASE / INNER BASE/ FOND INTERIEUR:	78 mm
ESPESOR / THICKNESS / ÉPAISSEUR:	2.5 mm
PESO/ WEIGHT / POIDS:	100 g

DESCRIPCIÓN: Cono liso.
MATERIAL: Polipropileno.

DESCRIPTION: Smooth cone.
MATERIAL: Polypropylene.

LA DESCRIPTION: Cone lisse.
MATÉRIEL: Polypropylène.

CONO LISO
SMOOTH CONE
CONE LISSE

PUNTA DEL CONO

Ø I.P 46 mm



BASE DEL CONO

Ø I.B 78 mm

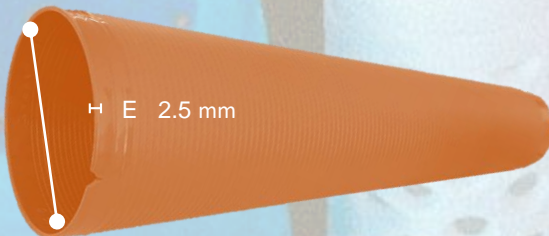

H E 2.5 mm

PUNTA



BASE

LONGITUD
272 mm

COLORES
REPRESENTATIVOS



La Mambra d'Oris. Ctra. C-17, km. 78, 08573 ORIS (Barcelona-Spain)

Tel. +34 93 859 26 61 / 62 607 26 95

E-mail: comercial@multiplasticos.es





TRIPLASSA
desde 1966

MULTIPLÁSTICOS
INYECTADOS S.L.

REF. 3022

CONO 3° 30 LISO

MEDIDAS / MEASURES / LES MESURES

CONICIDAD/ CONICITY/ CONICITÉ:	3° 30
LONGITUD/ LENGTH/ LONGEUR:	230 mm
Ø INTERIOR PUNTA/ INSIDE TIP/ POINTE INTÉRIEURE:	32.5 mm
Ø INTERIOR BASE / INNER BASE/ FOND INTERIEUR:	71.5 mm
ESPESOR / THICKNESS / ÉPAISSEUR:	2 mm
PESO/ WEIGHT / POIDS:	66 g

DESCRIPCIÓN: Cono liso.
MATERIAL: Polipropileno.

DESCRIPTION: Smooth cone.
MATERIAL: Polypropylene.

LA DESCRIPTION: Cone lisse.
MATÉRIEL: Polypropylène.

CONO LISO
SMOOTH CONE
CONE LISSE

PUNTA DEL CONO

Ø I.P 32.5 mm

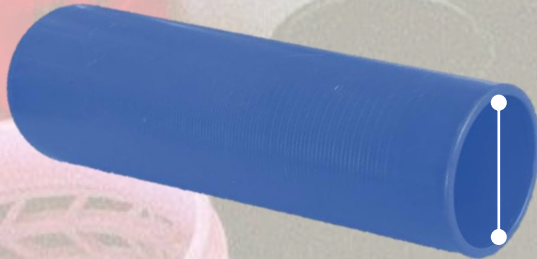

BASE DEL CONO

Ø I.B 71.5 mm

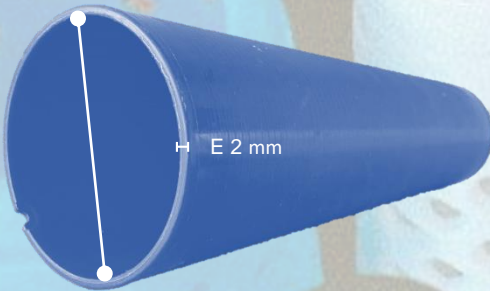

PUNTA

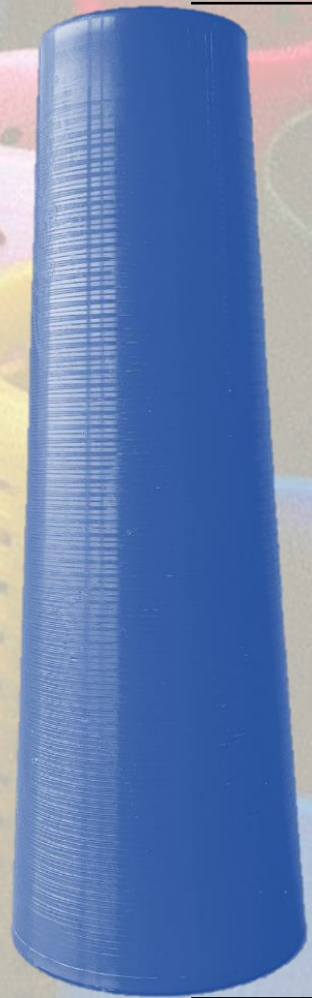

LONGITUD
230 mm

BASE

COLORES
REPRESENTATIVOS

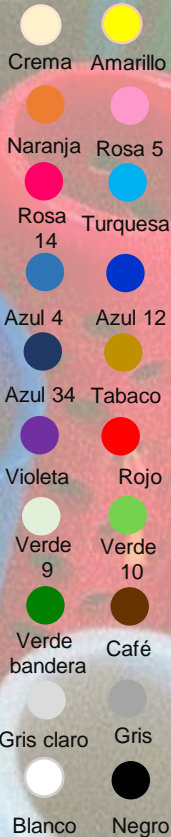

La Mambra d'Oris. Ctra. C-17, km. 78, 08573 ORIS (Barcelona-Spain)

Tel. +34 93 859 26 61 / 62 607 26 95

E-mail: comercial@multiplasticos.es





TRIPLASSA
desde 1966

MULTIPLÁSTICOS
INYECTADOS S.L.

REF. 3029

CONO 3° 30 LISO

MEDIDAS / MEASURES / LES MESURES

CONICIDAD/ CONICITY/ CONICITÉ:	3° 30
LONGITUD/ LENGTH/ LONGEUR:	230 mm
Ø INTERIOR PUNTA/ INSIDE TIP/ POINTE INTÉRIEURE:	26.5 mm
Ø INTERIOR BASE / INNER BASE/ FOND INTERIEUR:	54 mm
ESPESOR / THICKNESS / ÉPAISSEUR:	2 mm
PESO/ WEIGHT / POIDS:	50 g

DESCRIPCIÓN: Cono liso.
MATERIAL: Polipropileno.

DESCRIPTION: Smooth cone.
MATERIAL: Polypropylene.

LA DESCRIPTION: Cone lisse.
MATÉRIEL: Polypropylène.

CONO LISO
SMOOTH CONE
CONE LISSE

PUNTA DEL CONO

Ø I.P 26.5 mm



BASE DEL CONO

Ø I.B 54 mm

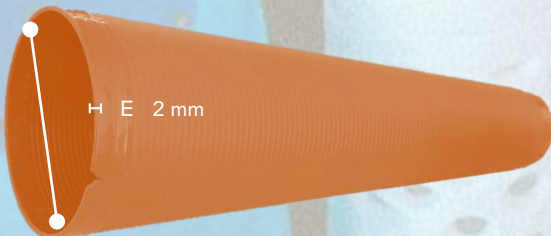

H E 2 mm

PUNTA



BASE

LONGITUD
230 mm

COLORES
REPRESENTATIVOS



La Mambra d'Oris. Ctra. C-17, km. 78, 08573 ORIS (Barcelona-Spain)

Tel. +34 93 859 26 61 / 62 607 26 95

E- mail: comercial@multiplasticos.es



MEDIDAS / MEASURES / LES MESURES

CONICIDAD/ CONICITY/ CONICITÉ:	3° 30
LONGITUD/ LENGTH/ LONGEUR:	260 mm
Ø INTERIOR PUNTA/ INSIDE TIP/ POINTE INTÉRIEURE:	31 mm
Ø INTERIOR BASE / INNER BASE/ FOND INTERIEUR:	72 mm
ESPESOR / THICKNESS / ÉPAISSEUR:	2 mm
PESO/ WEIGHT / POIDS:	65 g

DESCRIPCIÓN: Cono liso.
MATERIAL: Polipropileno.

DESCRIPTION: Smooth cone.
MATERIAL: Polypropylene.

LA DESCRIPTION: Cone lisse.
MATÉRIEL: Polypropylène.

CONO LISO
SMOOTH CONE
CONE LISSE

PUNTA DEL CONO
Ø I.P 31 mm

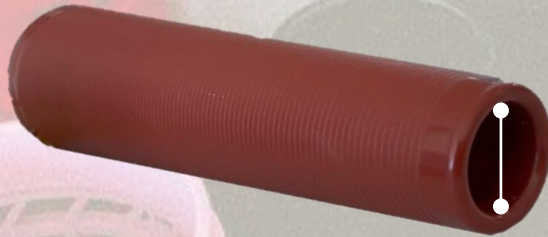

BASE DEL CONO
Ø I.B 72 mm

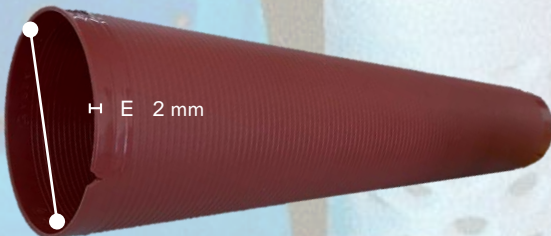

PUNTA



LONGITUD
260 mm

BASE

COLORES REPRESENTATIVOS

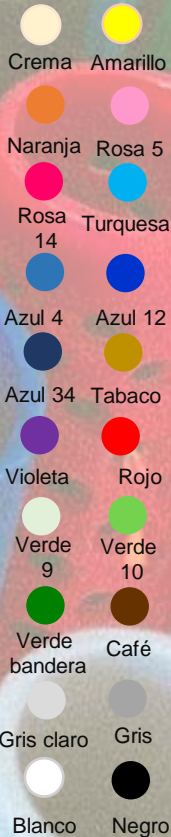



TRIPLASSA
desde 1966

MULTIPLÁSTICOS
INYECTADOS S.L.

REF. 4020

CONO 4° 20 LISO

MEDIDAS / MEASURES / LES MESURES

CONICIDAD/ CONICITY/ CONICITÉ:	4° 20
LONGITUD/ LENGTH/ LONGEUR:	170 mm
Ø INTERIOR PUNTA/ INSIDE TIP/ POINTE INTÉRIEURE:	33 mm
Ø INTERIOR BASE / INNER BASE/ FOND INTERIEUR:	59 mm
ESPESOR / THICKNESS / ÉPAISSEUR:	2.0 mm
PESO/ WEIGHT / POIDS:	37 g

DESCRIPCIÓN: Cono liso.
MATERIAL: Polipropileno.

DESCRIPTION: Smooth cone.
MATERIAL: Polypropylene.

LA DESCRIPTION: Cone lisse.
MATÉRIEL: Polypropylène .

CONO LISO
SMOOTH CONE
CONE LISSE

PUNTA DEL CONO
Ø I.P 33 mm



BASE DEL CONO
Ø I.B 59 mm

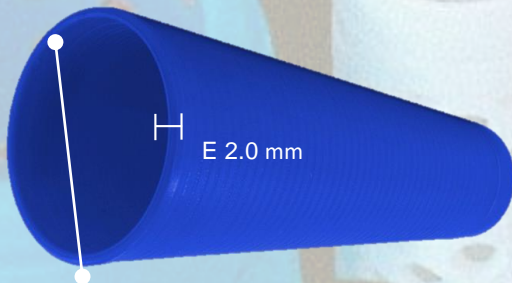

PUNTA



LONGITUD
170 mm

BASE

COLORES REPRESENTATIVOS



La Mambra d'Oris. Ctra. C-17, km. 78, 08573 ORIS (Barcelona-Spain)

Tel. +34 93 859 26 61 / 62 607 26 95

E- mail: comercial@multiplasticos.es



MEDIDAS / MEASURES / LES MESURES

CONICIDAD/ CONICITY/ CONICITÉ:	4° 20
LONGITUD/ LENGTH/ LONGEUR:	280 mm
Ø INTERIOR PUNTA/ INSIDE TIP/ POINTE INTÉRIEURE:	33 mm
Ø INTERIOR BASE / INNER BASE/ FOND INTERIEUR:	75 mm
ESPESOR / THICKNESS / ÉPAISSEUR:	2 mm
PESO/ WEIGHT / POIDS:	69 g

DESCRIPCIÓN: Cono liso.
MATERIAL: Polipropileno.

DESCRIPTION: Smooth cone.
MATERIAL: Polypropylene.

LA DESCRIPTION: Cone lisse.
MATÉRIEL: Polypropylène .

CONO LISO
SMOOTH CONE
CONE LISSE

PUNTA DEL CONO
Ø I.P 33 mm

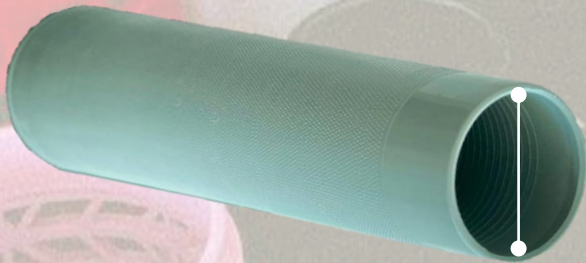

BASE DEL CONO
Ø I.B 75 mm

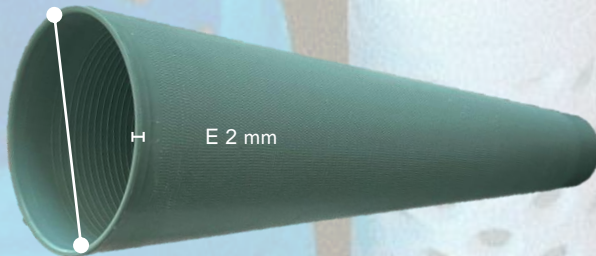

PUNTA



LONGITUD
280 mm

BASE

COLORES REPRESENTATIVOS

- Crema
- Amarillo
- Naranja
- Rosa 5
- Rosa 14
- Turquesa
- Azul 4
- Azul 12
- Azul 34
- Tabaco
- Violeta
- Rojo
- Verde 9
- Verde 10
- Verde bandera
- Café
- Gris claro
- Gris
- Blanco
- Negro



MEDIDAS / MEASURES / LES MESURES

CONICIDAD/ CONICITY/ CONICITÉ:	5° 57
LONGITUD/ LENGTH/ LONGEUR:	175 mm
Ø INTERIOR PUNTA/ INSIDE TIP/ POINTE INTÉRIEURE:	21.5 mm
Ø INTERIOR BASE / INNER BASE/ FOND INTERIEUR:	65 mm
ESPESOR / THICKNESS / ÉPAISSEUR:	1.4 mm
PESO/ WEIGHT / POIDS:	32 g

DESCRIPCIÓN: Cono liso.
MATERIAL: Polipropileno.

DESCRIPTION: Smooth cone.
MATERIAL: Polypropylene.

LA DESCRIPTION: Cone lisse.
MATÉRIEL: Polypropylène.

CONO LISO
SMOOTH CONE
CONE LISSE

PUNTA DEL CONO
Ø I.P 21.5 mm



BASE DEL CONO
Ø I.B 65 mm

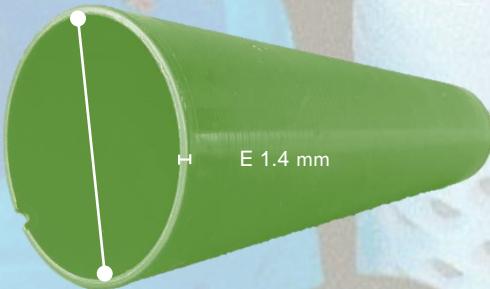

PUNTA

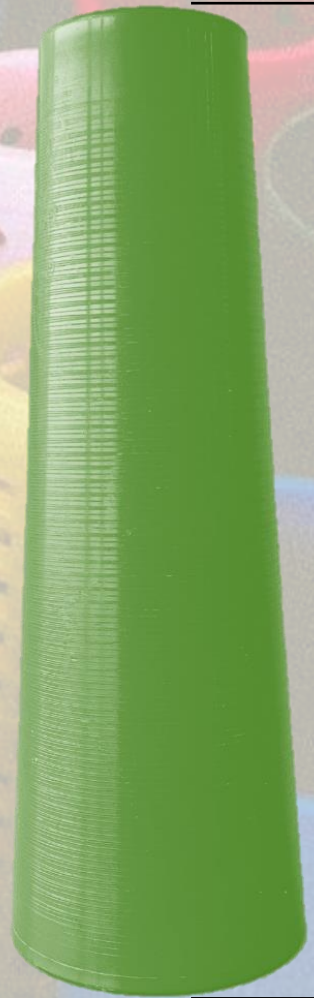

LONGITUD
175 mm

BASE

COLORES REPRESENTATIVOS

- Crema
- Amarillo
- Naranja
- Rosa 5
- Rosa 14
- Turquesa
- Azul 4
- Azul 12
- Azul 34
- Tabaco
- Violeta
- Rojo
- Verde 9
- Verde 10
- Verde bandera
- Café
- Gris claro
- Gris
- Blanco
- Negro





TRIPLASSA
desde 1966

MULTIPLÁSTICOS
INYECTADOS S.L.

REF. 5030

CONO 5° 57 LISO

MEDIDAS / MEASURES / LES MESURES

CONICIDAD/ CONICITY/ CONICITÉ:	5° 57
LONGITUD/ LENGTH/ LONGEUR:	115 mm
Ø INTERIOR PUNTA/ INSIDE TIP/ POINTE INTÉRIEURE:	11 mm
Ø INTERIOR BASE / INNER BASE/ FOND INTERIEUR:	35 mm
ESPESOR / THICKNESS / ÉPAISSEUR:	1.7 mm
PESO/ WEIGHT / POIDS:	18 g

DESCRIPCIÓN: Cono liso.
MATERIAL: Polipropileno.

DESCRIPTION: Smooth cone.
MATERIAL: Polypropylene.

LA DESCRIPTION: Cone lisse.
MATÉRIEL: Polypropylène.

CONO LISO
SMOOTH CONE
CONE LISSE

PUNTA DEL CONO

Ø I.P 11 mm

PUNTA



BASE DEL CONO

Ø I.B 35 mm



H E 1.7 mm

BASE

LONGITUD
115 mm

COLORES
REPRESENTATIVOS



La Mambra d'Oris. Ctra. C-17, km. 78, 08573 ORIS (Barcelona-Spain)

Tel. +34 93 859 26 61 / 62 607 26 95

E-mail: comercial@multiplasticos.es



MEDIDAS / MEASURES / LES MESURES

CONICIDAD/ CONICITY/ CONICITÉ:	4°
LONGITUD/ LENGTH/ LONGEUR:	255 mm
Ø INTERIOR PUNTA/ INSIDE TIP/ POINTE INTÉRIEURE:	20 mm
Ø INTERIOR BASE / INNER BASE/ FOND INTERIEUR:	62 mm
ESPESOR / THICKNESS / ÉPAISSEUR:	2.0 mm
PESO/ WEIGHT / POIDS:	61 g

DESCRIPCIÓN: Cono liso.
MATERIAL: Polipropileno.

DESCRIPTION: Smooth cone.
MATERIAL: Polypropylene.

LA DESCRIPTION: Cone lisse.
MATÉRIEL: Polypropylène .

CONO LISO
SMOOTH CONE
CONE LISSE

PUNTA DEL CONO
Ø I.P 20 mm



BASE DEL CONO
Ø I.B 62mm

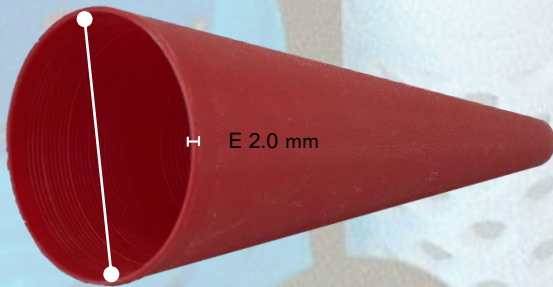

PUNTA



LONGITUD
255 mm

BASE

COLORES REPRESENTATIVOS

- Crema
- Amarillo
- Naranja
- Rosa 5
- Rosa 14
- Turquesa
- Azul 4
- Azul 12
- Azul 34
- Tabaco
- Violeta
- Rojo
- Verde 9
- Verde 10
- Verde bandera
- Café
- Gris claro
- Gris
- Blanco
- Negro





TRIPLASSA
desde 1966

MULTIPLÁSTICOS
INYECTADOS S.L.

REF. 8005

CONO 1° 51 LIÑO

MEDIDAS / MEASURES / LES MESURES

CONICIDAD/ CONICITY/ CONICITÉ:	1° 51
LONGITUD/ LENGTH/ LONGEUR:	170 mm
Ø INTERIOR PUNTA/ INSIDE TIP/ POINTE INTÉRIEURE:	87 mm
Ø INTERIOR BASE / INNER BASE/ FOND INTERIEUR:	98 mm
ESPEOR / THICKNESS / ÉPAISSEUR:	3.5 mm
PESO/ WEIGHT / POIDS:	141 g

DESCRIPCIÓN: Cono liso.
MATERIAL: Polipropileno.

DESCRIPTION: Smooth cone.
MATERIAL: Polypropylene.

LA DESCRIPTION: Cone lisse.
MATÉRIEL: Polypropylène.

CONO LIÑO
SMOOTH CONE
CONE LISSÉ

PUNTA DEL CONO

Ø I.P 87 mm

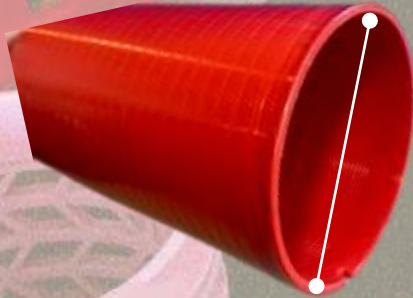

BASE DEL CONO

Ø I.B 98mm

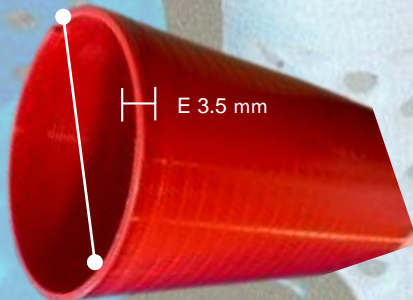

PUNTA



BASE

LONGITUD
170 mm

COLORES
REPRESENTATIVOS

- | | |
|---------------|----------|
| | |
| Crema | Amarillo |
| | |
| Naranja | Rosa 5 |
| | |
| Rosa 14 | Turquesa |
| | |
| Azul 4 | Azul 12 |
| | |
| Azul 34 | Tabaco |
| | |
| Violeta | Rojo |
| | |
| Verde 9 | Verde 10 |
| | |
| Verde bandera | Café |
| | |
| Gris claro | Gris |
| | |
| Blanco | Negro |



La Mambla d'Oris. Ctra. C-17, km. 78, 08573 ORIS (Barcelona-Spain)

Tel. +34 93 859 26 61 / 62 607 26 95

E-mail: comercial@multiplasticos.es





TRIPLASSA
desde 1966

MULTIPLÁSTICOS
INYECTADOS S.L.

REF. 8020

CONO 2° LISO

MEDIDAS / MEASURES / LES MESURES

CONICIDAD/ CONICITY/ CONICITÉ:	2°
LONGITUD/ LENGTH/ LONGEUR:	170 mm
Ø INTERIOR PUNTA/ INSIDE TIP/ POINTE INTÉRIEURE:	44.5 mm
Ø INTERIOR BASE / INNER BASE/ FOND INTERIEUR:	65 mm
ESPESOR / THICKNESS / ÉPAISSEUR:	2 mm
PESO/ WEIGHT / POIDS:	52 g

DESCRIPCIÓN: Cono liso.
MATERIAL: Polipropileno.

DESCRIPTION: Smooth cone.
MATERIAL: Polypropylene.

LA DESCRIPTION: Cone lisse.
MATÉRIEL: Polypropylène .

CONO LISO
SMOOTH CONE
CONE LISSE

PUNTA DEL CONO

Ø I.P 44.5 mm



BASE DEL CONO

Ø I.B 65 mm

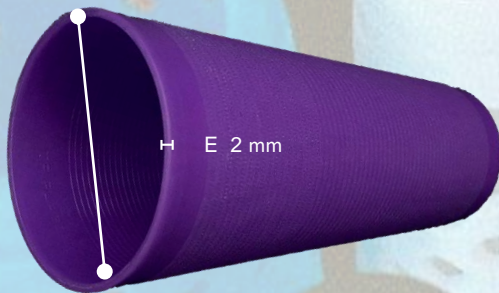

H E 2 mm

PUNTA



LONGITUD
170 mm

BASE

COLORES
REPRESENTATIVOS

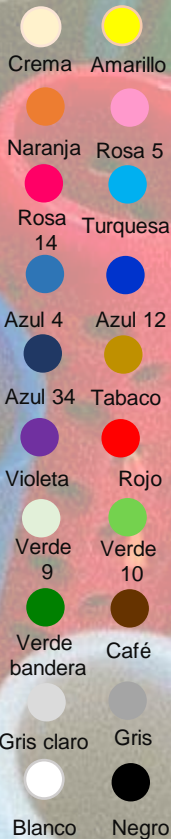

La Mambra d'Oris. Ctra. C-17, km. 78, 08573 ORIS (Barcelona-Spain)



Tel. +34 93 859 26 61 / 62 607 26 95



E- mail: comercial@multiplasticos.es





CONOS

PERFORADOS



TRIPLASSA
desde 1966

MULTIPLÁSTICOS
INYECTADOS S.L.

MEDIDAS / MEASURES / LES MESURES

CONICIDAD/ CONICITY/ CONICITÉ:	4° 20
LONGITUD/ LENGTH/ LONGEUR:	145 mm
Ø INTERIOR PUNTA/ INSIDE TIP/ POINTE INTÉRIEURE:	33 mm
Ø INTERIOR BASE / INNER BASE/ FOND INTERIEUR:	55 mm
ESPESOR / THICKNESS / ÉPAISSEUR:	1.8 mm
PESO/ WEIGHT / POIDS:	24 g

DESCRIPCIÓN: Cono perforado.
MATERIAL: Polipropileno.

DESCRIPTION: Perforated cone.
MATERIAL: Polypropylene.

LA DESCRIPTION: Cone Perforé.
MATÉRIEL: Polypropylène.

CONO PERFORADO
PERFORATED CONE
CONE PERFORÉ

PUNTA DEL CONO
Ø I.P 33 mm



BASE DEL CONO
Ø I.B 55 mm

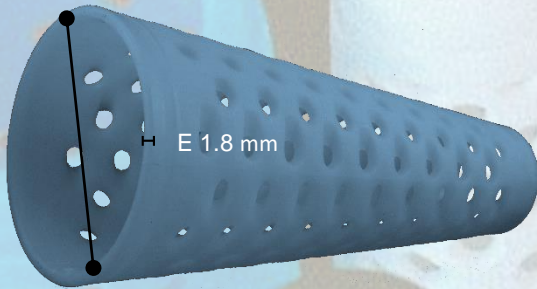

PUNTA



LONGITUD
145 mm

BASE

COLORES REPRESENTATIVOS

- Crema
- Amarillo
- Naranja
- Rosa 5
- Rosa 14
- Turquesa
- Azul 4
- Azul 12
- Azul 34
- Tabaco
- Violeta
- Rojo
- Verde 9
- Verde 10
- Verde bandera
- Café
- Gris claro
- Gris
- Blanco
- Negro



MEDIDAS / MEASURES / LES MESURES

CONICIDAD/ CONICITY/ CONICITÉ:	3° 30
LONGITUD/ LENGTH/ LONGEUR:	175 mm
Ø INTERIOR PUNTA/ INSIDE TIP/ POINTE INTÉRIEURE:	24.7 mm
Ø INTERIOR BASE / INNER BASE/ FOND INTERIEUR:	46 mm
ESPESOR / THICKNESS / ÉPAISSEUR:	2.0 mm
PESO/ WEIGHT / POIDS:	26 g

DESCRIPCIÓN: Cono perforado.
MATERIAL: Polipropileno.

DESCRIPTION: Perforated cone.
MATERIAL: Polypropylene.

LA DESCRIPTION: Cone Perforé.
MATÉRIEL: Polypropylène.

CONO PERFORADO
PERFORATED CONE
CONE PERFORÉ

PUNTA DEL CONO
Ø I.P 22.5 mm

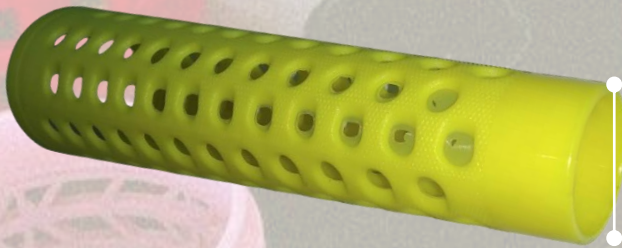

BASE DEL CONO
Ø I.B 65 mm

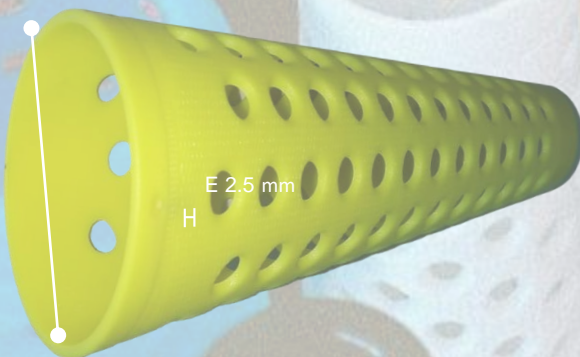

E 2.5 mm
H

PUNTA



BASE

LONGITUD
177 mm

COLORES REPRESENTATIVOS





TRIPLASSA
desde 1966

MULTIPLÁSTICOS
INYECTADOS S.L.

REF. 3023

CONO 3° 30 PERFORADO

MEDIDAS / MEASURES / LES MESURES

CONICIDAD/ CONICITY/ CONICITÉ:	3° 30
LONGITUD/ LENGTH/ LONGEUR:	175 mm
Ø INTERIOR PUNTA/ INSIDE TIP/ POINTE INTÉRIEURE:	31 mm
Ø INTERIOR BASE / INNER BASE/ FOND INTERIEUR:	62 mm
ESPESOR / THICKNESS / ÉPAISSEUR:	3.5 mm
PESO/ WEIGHT / POIDS:	84 g

DESCRIPCIÓN: Cono Perforado.
MATERIAL: Polipropileno.

DESCRIPTION: Perforated cone.
MATERIAL: Polypropylene.

LA DESCRIPTION: Cone perforé.
MATÉRIEL: Polypropylène .

CONO PERFORADO
PERFORATED CONE
CONE PERFORÉ

PUNTA DEL CONO

Ø I.P 31 mm



BASE DEL CONO

Ø I.B 62 mm

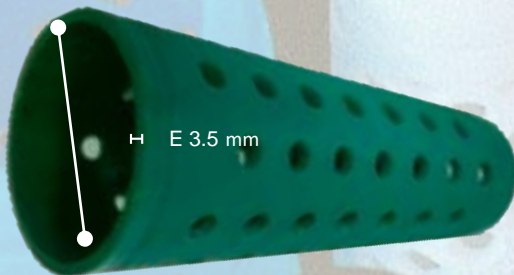

H E 3.5 mm

PUNTA



BASE

LONGITUD
175 mm

COLORES
REPRESENTATIVOS



La Mambra d'Oris. Ctra. C-17, km. 78, 08573 ORIS (Barcelona-Spain)



Tel. +34 93 859 26 61 / 62 607 26 95



E- mail: comercial@multiplasticos.es





TRIPLASSA
desde 1966

MULTIPLÁSTICOS
INYECTADOS S.L.

REF. 4013

CONO 4° 20 PERFORADO

MEDIDAS / MEASURES / LES MESURES

CONICIDAD/ CONICITY/ CONICITÉ:	4° 20
LONGITUD/ LENGTH/ LONGEUR:	170 mm
Ø INTERIOR PUNTA/ INSIDE TIP/ POINTE INTÉRIEURE:	33 mm
Ø INTERIOR BASE / INNER BASE/ FOND INTERIEUR:	59 mm
ESPESOR / THICKNESS / ÉPAISSEUR:	4.5 mm
PESO/ WEIGHT / POIDS:	64.0 g

DESCRIPCIÓN: Cono perforado.
MATERIAL: Polipropileno.

DESCRIPTION: Perforated cone.
MATERIAL: Polypropylene.

LA DESCRIPTION: Cone Perforé.
MATÉRIEL: Polypropylène.

CONO PERFORADO
PERFORATED CONE
CONE PERFORÉ

PUNTA

PUNTA DEL CONO

Ø I.P 33 mm



BASE

BASE DEL CONO

Ø I.B 59 mm



E 4.5 mm

LONGITUD
170 mm

COLORES
REPRESENTATIVOS



La Mambla d'Oris. Ctra. C-17, km. 78, 08573 ORIS (Barcelona-Spain)

Tel. +34 93 859 26 61 / 62 607 26 95

E- mail: comercial@multiplasticos.es





TRIPLASSA
desde 1966

MULTIPLÁSTICOS
INYECTADOS S.L.

REF. 4019.1

CONO 4° 20 PERFORADO

MEDIDAS / MEASURES / LES MESURES

CONICIDAD/ CONICITY/ CONICITÉ:	4° 20
LONGITUD/ LENGTH/ LONGEUR:	170 mm
Ø INTERIOR PUNTA/ INSIDE TIP/ POINTE INTÉRIEURE:	33 mm
Ø INTERIOR BASE / INNER BASE/ FOND INTERIEUR:	59 mm
ESPESOR / THICKNESS / ÉPAISSEUR:	1.5 mm
PESO/ WEIGHT / POIDS:	27 g

DESCRIPCIÓN: Cono perforado.
MATERIAL: Polipropileno.

DESCRIPTION: Perforated cone.
MATERIAL: Polypropylene.

LA DESCRIPTION: Cone Perforé.
MATÉRIEL: Polypropylène.

CONO PERFORADO
PERFORATED CONE
CONE PERFORÉ

PUNTA DEL CONO
Ø I.P 33 mm



BASE DEL CONO
Ø I.B 59 mm

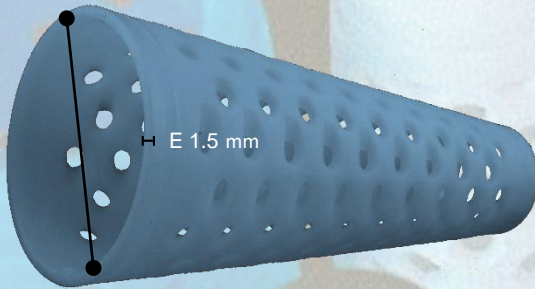

H E 1.5 mm

PUNTA



LONGITUD
170 mm

BASE

COLORES REPRESENTATIVOS

- Crema
- Amarillo
- Naranja
- Rosa 5
- Rosa 14
- Turquesa
- Azul 4
- Azul 12
- Azul 34
- Tabaco
- Violeta
- Rojo
- Verde 9
- Verde 10
- Verde bandera
- Café
- Gris claro
- Gris
- Blanco
- Negro

La Mambra d'Oris. Ctra. C-17, km. 78, 08573 ORIS (Barcelona-Spain)

Tel. +34 93 859 26 61 / 62 607 26 95

E- mail: comercial@multiplasticos.es



MEDIDAS / MEASURES / LES MESURES

CONICIDAD/ CONICITY/ CONICITÉ:	4° 20
LONGITUD/ LENGTH/ LONGEUR:	170 mm
Ø INTERIOR PUNTA/ INSIDE TIP/ POINTE INTÉRIEURE:	33 mm
Ø INTERIOR BASE / INNER BASE/ FOND INTERIEUR:	59 mm
ESPESOR / THICKNESS / ÉPAISSEUR:	2.2 mm
PESO/ WEIGHT / POIDS:	40 g

DESCRIPCIÓN: Cono perforado.
MATERIAL: Polipropileno.

DESCRIPTION: Perforated cone.
MATERIAL: Polypropylene.

LA DESCRIPTION: Cone Perforé.
MATÉRIEL: Polypropylène.

CONO PERFORADO
PERFORATED CONE
CONE PERFORÉ

PUNTA DEL CONO
Ø I.P 33 mm



BASE DEL CONO
Ø I.B 59 mm

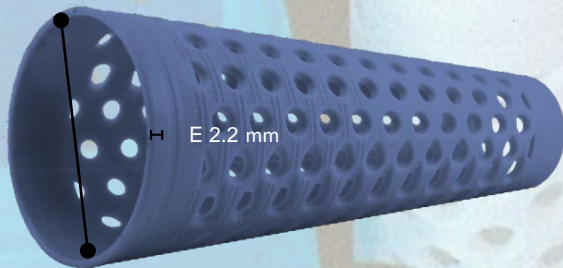

PUNTA

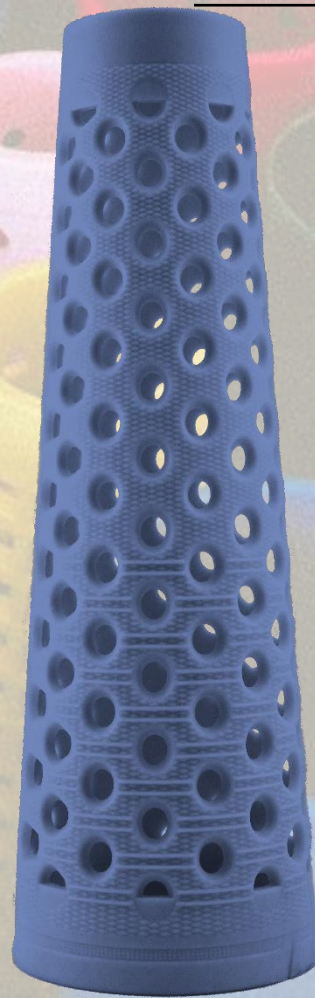

LONGITUD
170 mm

BASE

COLORES REPRESENTATIVOS





TRIPLASSA
desde 1966

MULTIPLÁSTICOS
INYECTADOS S.L.

REF. 4044

CONO 4° 20 PERFORADO

MEDIDAS / MEASURES / LES MESURES

CONICIDAD/ CONICITY/ CONICITÉ:	4° 20
LONGITUD/ LENGTH/ LONGEUR:	225 mm
Ø INTERIOR PUNTA/ INSIDE TIP/ POINTE INTÉRIEURE:	33 mm
Ø INTERIOR BASE / INNER BASE/ FOND INTERIEUR:	68 mm
ESPESOR / THICKNESS / ÉPAISSEUR:	3 mm
PESO/ WEIGHT / POIDS:	50 g

DESCRIPCIÓN: Cono perforado.
MATERIAL: Polipropileno.

DESCRIPTION: Perforated cone.
MATERIAL: Polypropylene.

LA DESCRIPTION: Cone Perforé.
MATÉRIEL: Polypropylène.

CONO PERFORADO
PERFORATED CONE
CONE PERFORÉ

PUNTA DEL CONO
Ø I.P 33 mm

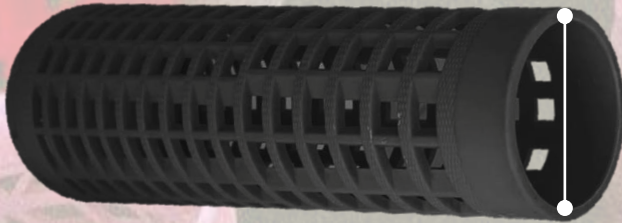

BASE DEL CONO
Ø I.B 68 mm

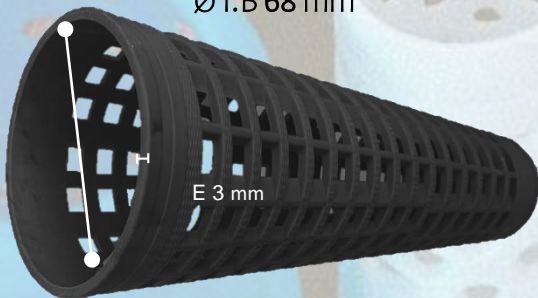

PUNTA

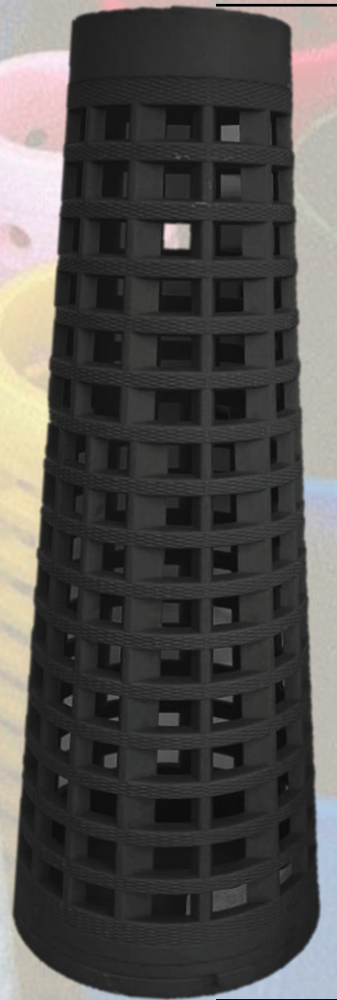

LONGITUD
225 mm

BASE

COLORES
REPRESENTATIVOS

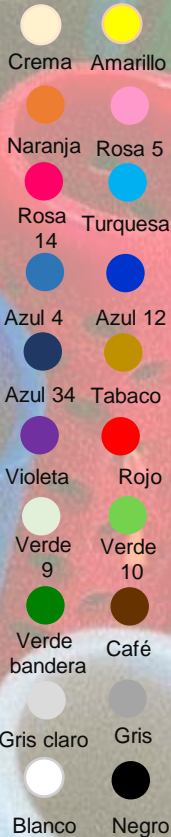

La Mambra d'Oris. Ctra. C-17, km. 78, 08573 ORIS (Barcelona-Spain)

Tel. +34 93 859 26 61 / 62 607 26 95

E-mail: comercial@multiplasticos.es





TRIPLASSA
desde 1966

MULTIPLÁSTICOS
INYECTADOS S.L.

REF. 4047.1

CONO 4° 20 PERFORADO

MEDIDAS / MEASURES / LES MESURES

CONICIDAD/ CONICITY/ CONICITÉ:	4° 20
LONGITUD/ LENGTH/ LONGEUR:	145 mm
Ø INTERIOR PUNTA/ INSIDE TIP/ POINTE INTÉRIEURE:	33 mm
Ø INTERIOR BASE / INNER BASE/ FOND INTERIEUR:	55 mm
ESPESOR / THICKNESS / ÉPAISSEUR:	3 mm
PESO/ WEIGHT / POIDS:	50 g

DESCRIPCIÓN: Cono perforado.
MATERIAL: Polipropileno.

DESCRIPTION: Perforated cone.
MATERIAL: Polypropylene.

LA DESCRIPTION: Cone Perforé.
MATÉRIEL: Polypropylène.

CONO PERFORADO
PERFORATED CONE
CONE PERFORÉ

PUNTA DEL CONO
Ø I.P 33 mm



BASE DEL CONO
Ø I.B 55 mm

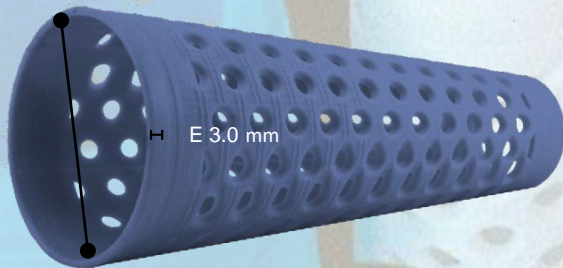

PUNTA

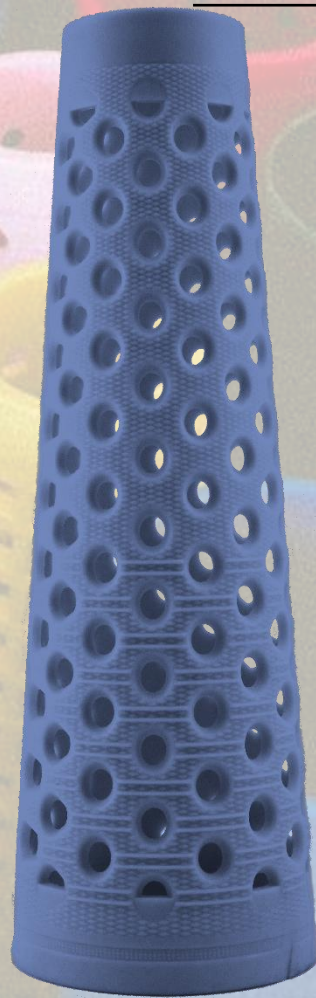

LONGITUD
145 mm

BASE

COLORES
REPRESENTATIVOS

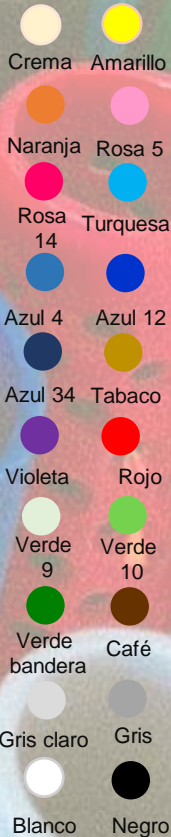

La Mambla d'Oris. Ctra. C-17, km. 78, 08573 ORIS (Barcelona-Spain)

Tel. +34 93 859 26 61 / 62 607 26 95

E- mail: comercial@multiplasticos.es



REF. 4060.1

CONO 4° 20 PERFORADO

MEDIDAS / MEASURES / LES MESURES

CONICIDAD/ CONICITY/ CONICITÉ:	4° 20
LONGITUD/ LENGTH/ LONGEUR:	170 mm
Ø INTERIOR PUNTA/ INSIDE TIP/ POINTE INTÉRIEURE:	33 mm
Ø INTERIOR BASE / INNER BASE/ FOND INTERIEUR:	59 mm
ESPESOR / THICKNESS / ÉPAISSEUR:	3.5 mm
PESO/ WEIGHT / POIDS:	59 g

DESCRIPCIÓN: Cono perforado.
MATERIAL: Polipropileno.

DESCRIPTION: Perforated cone.
MATERIAL: Polypropylene.

LA DESCRIPTION: Cone Perforé.
MATÉRIEL: Polypropylène.

CONO PERFORADO
PERFORATED CONE
CONE PERFORÉ

PUNTA DEL CONO
Ø I.P 33 mm

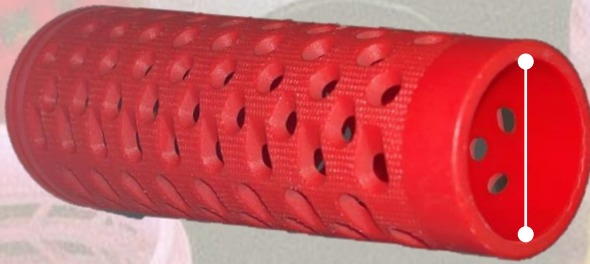

BASE DEL CONO
Ø I.B 59 mm

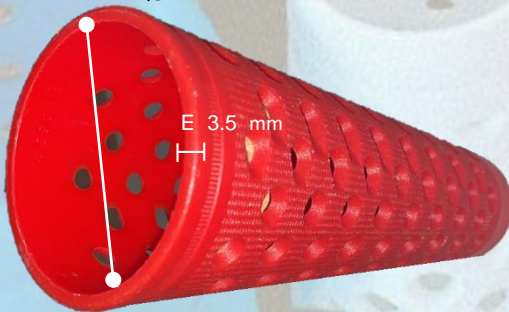

PUNTA



LONGITUD
170 mm

BASE

COLORES REPRESENTATIVOS

- Crema
- Amarillo
- Naranja
- Rosa 5
- Rosa 14
- Turquesa
- Azul 4
- Azul 12
- Azul 34
- Tabaco
- Violeta
- Rojo
- Verde 9
- Verde 10
- Verde bandera
- Café
- Gris claro
- Gris
- Blanco
- Negro



MEDIDAS / MEASURES / LES MESURES

CONICIDAD/ CONICITY/ CONICITÉ:	5° 57
LONGITUD/ LENGTH/ LONGEUR:	173 mm
Ø INTERIOR PUNTA/ INSIDE TIP/ POINTE INTÉRIEURE:	21.5 mm
Ø INTERIOR BASE / INNER BASE/ FOND INTERIEUR:	64 mm
ESPESOR / THICKNESS / ÉPAISSEUR:	1.4 mm
PESO/ WEIGHT / POIDS:	34 g

DESCRIPCIÓN: Cono perforado.
MATERIAL: Polipropileno.

DESCRIPTION: Perforated cone.
MATERIAL: Polypropylene.

LA DESCRIPTION: Cone Perforé.
MATÉRIEL: Polypropylène.

CONO PERFORADO
PERFORATED CONE
CONE PERFORÉ

PUNTA DEL CONO
Ø I.P 21.5 mm

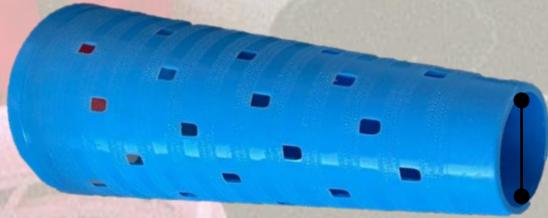

BASE DEL CONO
Ø I.B 64 mm

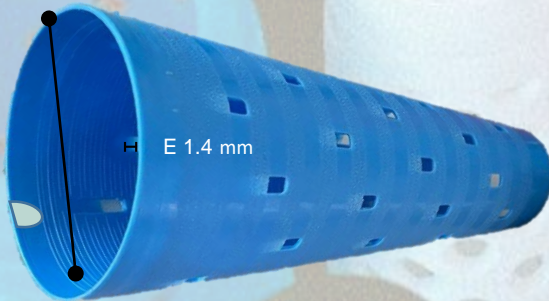

H E 1.4 mm

PUNTA



LONGITUD
173 mm

BASE

COLORES REPRESENTATIVOS

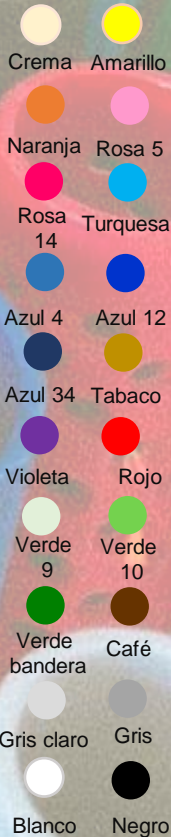

MEDIDAS / MEASURES / LES MESURES

CONICIDAD/ CONICITY/ CONICITÉ:	5° 57
LONGITUD/ LENGTH/ LONGEUR:	170 mm
Ø INTERIOR PUNTA/ INSIDE TIP/ POINTE INTÉRIEURE:	30 mm
Ø INTERIOR BASE / INNER BASE/ FOND INTERIEUR:	68 mm
ESPESOR / THICKNESS / ÉPAISSEUR:	1.4 mm
PESO/ WEIGHT / POIDS:	30 g

DESCRIPCIÓN: Cono perforado.
MATERIAL: Polipropileno.

DESCRIPTION: Perforated cone.
MATERIAL: Polypropylene.

LA DESCRIPTION: Cone Perforé.
MATÉRIEL: Polypropylène.

CONO PERFORADO
PERFORATED CONE
CONE PERFORÉ

PUNTA DEL CONO
Ø I.P 30 mm

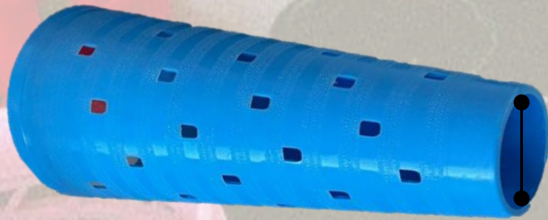

BASE DEL CONO
Ø I.B 68 mm

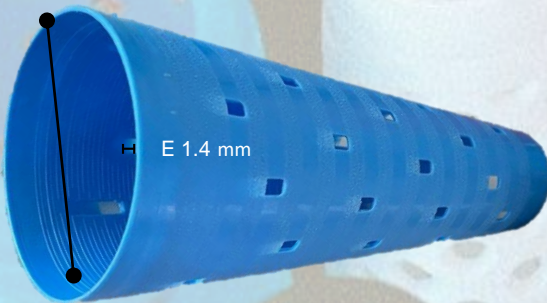

PUNTA



LONGITUD
170 mm

BASE

COLORES REPRESENTATIVOS

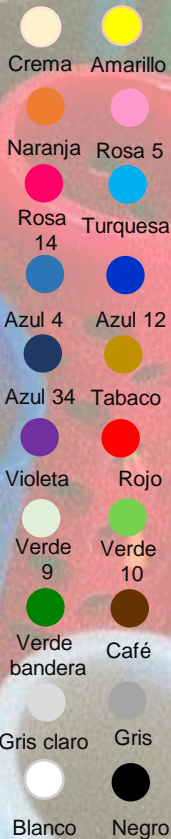



TRIPLASSA
desde 1966

MULTIPLÁSTICOS
INYECTADOS S.L.

REF. 5013

CONO 5° 57 PERFORADO

MEDIDAS / MEASURES / LES MESURES

CONICIDAD/ CONICITY/ CONICITÉ:	5° 57
LONGITUD/ LENGTH/ LONGEUR:	177 mm
Ø INTERIOR PUNTA/ INSIDE TIP/ POINTE INTÉRIEURE:	22.5 mm
Ø INTERIOR BASE / INNER BASE/ FOND INTERIEUR:	65 mm
ESPESOR / THICKNESS / ÉPAISSEUR:	2.5 mm
PESO/ WEIGHT / POIDS:	48 g

DESCRIPCIÓN: Cono perforado.
MATERIAL: Polipropileno.

DESCRIPTION: Perforated cone.
MATERIAL: Polypropylene.

LA DESCRIPTION: Cone Perforé.
MATÉRIEL: Polypropylène.

CONO PERFORADO
PERFORATED CONE
CONE PERFORÉ

PUNTA DEL CONO

Ø I.P 22.5 mm

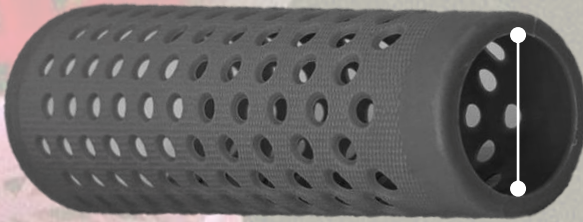

BASE DEL CONO

Ø I.B 65 mm

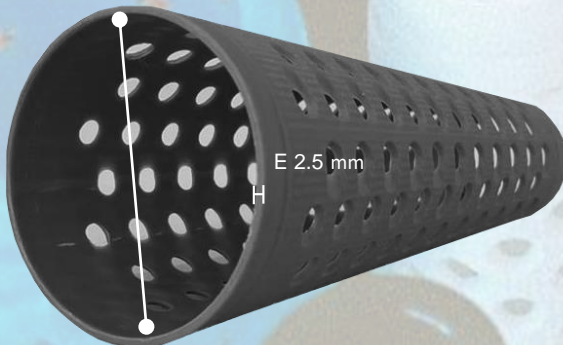

PUNTA

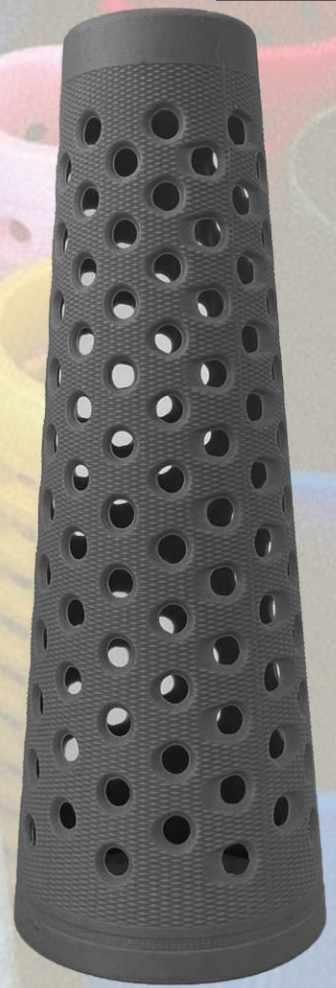

LONGITUD
177 mm

BASE

COLORES REPRESENTATIVOS

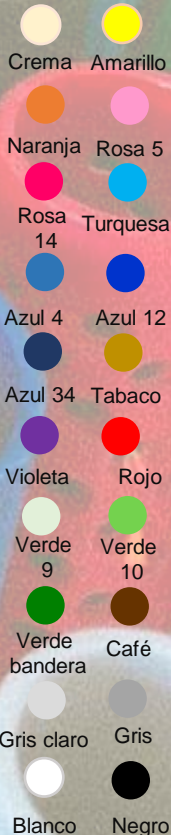

La Mambra d'Oris. Ctra. C-17, km. 78, 08573 ORIS (Barcelona-Spain)

Tel. +34 93 859 26 61 / 62 607 26 95

E-mail: comercial@multiplasticos.es





OTRAS FORMAS



TRIPLASSA
desde 1966

MULTIPLÁSTICOS
INYECTADOS S.L.

MEDIDAS / MEASURES / LES MESURES

LONGITUD / LENGTH / LONGEUR:	90 mm
Ø INTERIOR PUNTA/ INSIDE TIP / POINTE INTÉRIEURE:	45 mm
Ø INTERIOR BASE / INNER BASE/ FOND INTERIEUR:	45 mm
ESPESOR / THICKNESS / ÉPAISSEUR:	1.8 mm
PESO/ WEIGHT / POIDS:	10 g

DESCRIPCIÓN: Carrete
MATERIAL: Polipropileno.

DESCRIPTION: Carret Spool
MATERIAL: Polypropylene.

LA DESCRIPTION: Bobine
MATÉRIEL: Polypropylène.

PUNTA DEL CARRETE
Ø I.P 45 mm

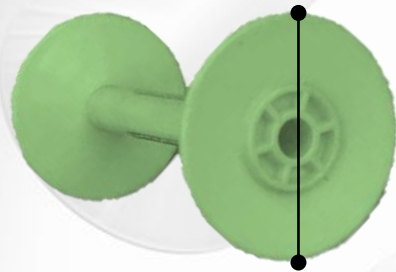

BASE DEL CARRETE
Ø I.B 45 mm

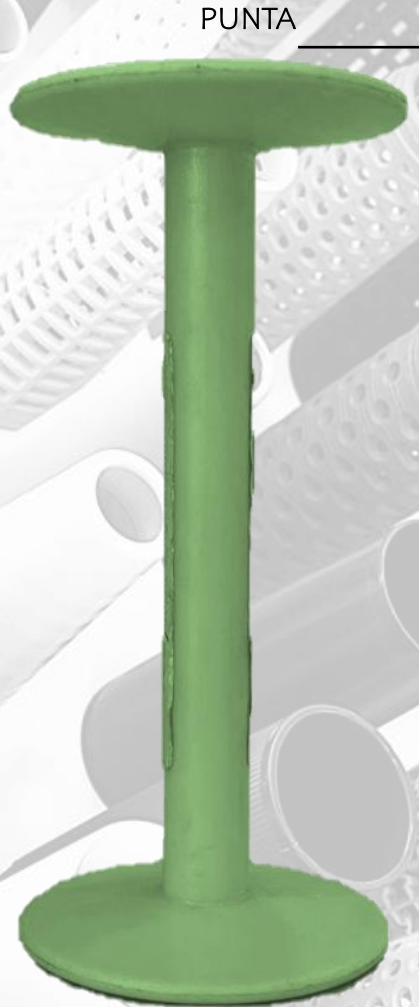
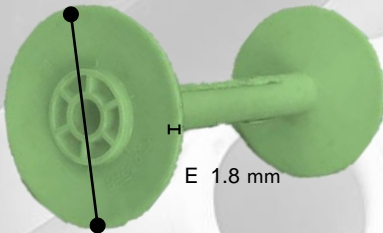

CARRETE
CARRET SPOOL
BOBINE

COLORES REPRESENTATIVOS



MEDIDAS / MEASURES / LES MESURES

LONGITUD / LENGTH / LONGEUR:	125 mm
Ø INTERIOR PUNTA/ INSIDE TIP / POINTE INTÉRIEURE:	60 mm
Ø INTERIOR BASE / INNER BASE/ FOND INTERIEUR:	60 mm
ESPESOR / THICKNESS / ÉPAISSEUR:	Mm
PESO/ WEIGHT / POIDS:	16 g

DESCRIPCIÓN: Carrete
MATERIAL: Polipropileno.

DESCRIPTION: Carret Spool
MATERIAL: Polypropylene.

LA DESCRIPTION: Bobine
MATÉRIEL: Polypropylène .

PUNTA DEL CARRETE
Ø I.P 60 mm

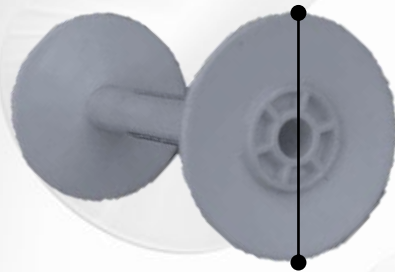

BASE DEL CARRETE
Ø I.B 60 mm

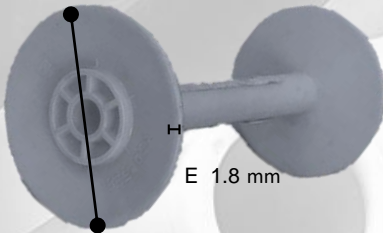

PUNTA

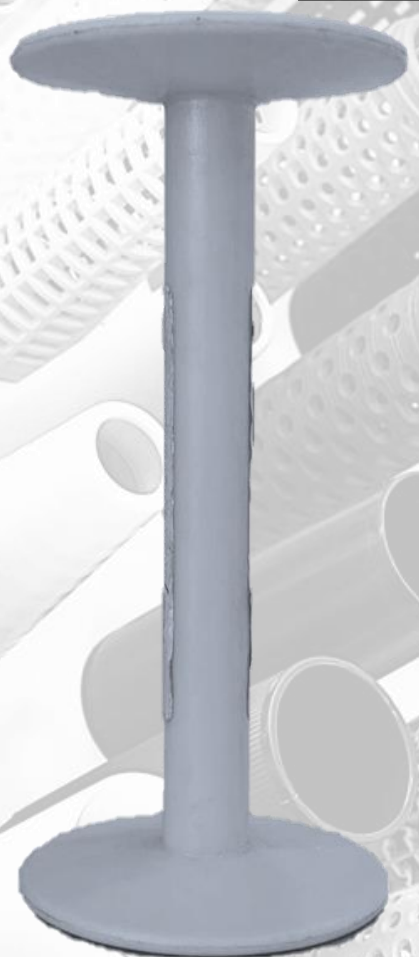

LONGITUD
106 mm

BASE

CARRETE
SCARRET POOL
BOBINE

COLORES REPRESENTATIVOS



MEDIDAS / MEASURES / LES MESURES

LONGITUD / LENGTH / LONGEUR:	130 mm
Ø INTERIOR PUNTA/ INSIDE TIP / POINTE INTÉRIEURE:	41 mm
Ø INTERIOR BASE / INNER BASE/ FOND INTERIEUR:	55 mm
ESPESOR / THICKNESS / ÉPAISSEUR:	mm
PESO/ WEIGHT / POIDS:	52 g

DESCRIPCIÓN: KING SPOOL.
MATERIAL: Polipropileno.

DESCRIPTION: KING SPOOL.
MATERIAL: Polypropylene.

LA DESCRIPTION: KING SPOOL.
MATÉRIEL: Polypropylène.

KING SPOOL

PUNTA

PUNTA
Ø I.P 41 mm



BASE
Ø I.B 55 mm



BASE

LONGITUD
130 mm

COLORES REPRESENTATIVOS



MEDIDAS / MEASURES / LES MESURES

LONGITUD / LENGTH / LONGEUR:	158 mm
Ø INTERIOR PUNTA / INSIDE TIP / POINTE INTÉRIEURE:	43 mm
Ø INTERIOR BASE / INNER BASE / FOND INTÉRIEUR:	57 mm
ESPESOR / THICKNESS / ÉPAISSEUR:	mm
PESO / WEIGHT / POIDS:	60 g

DESCRIPCIÓN: KING SPOOL.
MATERIAL: Polipropileno.

DESCRIPTION: KING SPOOL.
MATERIAL: Polypropylene.

LA DESCRIPTION: KING SPOOL.
MATÉRIEL: Polypropylène.

PUNTA

LONGITUD
158 mm

PUNTA
Ø I.P 43 mm

BASE

BASE
Ø I.B 57 mm

KING SPOOL

COLORES REPRESENTATIVOS





TRIPLASSA
desde 1966

MULTIPLÁSTICOS
INYECTADOS S.L.

OTRAS FORMAS

REF. 9153

ANILLO

MEDIDAS / MEASURES / LES MESURES

LONGITUD /LENGTH/ LONGEUR:	8 mm
Ø INTERIOR PUNTA/ INSIDE TIP /POINTE INTÉRIEURE:	70 mm
Ø INTERIOR BASE / INNER BASE/ FOND INTERIEUR:	22.5 mm

DESCRIPCIÓN: ANILLO.
MATERIAL: Polipropileno.

DESCRIPTION: RING.
MATERIAL: Polypropylene.

LA DESCRIPTION: BAGUE.
MATÉRIEL: Polypropylène.

COLORES
REPRESENTATIVOS

- Crema
- Amarillo
- Naranja
- Rosa 5
- Rosa 14
- Turquesa
- Azul 4
- Azul 12
- Azul 34
- Tabaco
- Violeta
- Rojo
- Verde 9
- Verde 10
- Verde bandera
- Café
- Gris claro
- Gris
- Blanco
- Negro



Ø I.P 92 mm



Ø I.P 70 mm

LONGITUD
22.5 mm



REF. 9116

ANILLO

MEDIDAS / MEASURES / LES MESURES

LONGITUD /LENGTH/ LONGEUR:	8 mm
Ø INTERIOR PUNTA/ INSIDE TIP /POINTE INTÉRIEURE:	30 mm
Ø INTERIOR BASE / INNER BASE/ FOND INTERIEUR:	36 mm

DESCRIPCIÓN: ANILLO.
MATERIAL: Polipropileno.

DESCRIPTION: RING.
MATERIAL: Polypropylene.

LA DESCRIPTION: BAGUE.
MATÉRIEL: Polypropylène.



Ø I.P 30 mm



LONGITUD
8 mm

Ø I.P 36 mm

REF. 9159

ANILLO

MEDIDAS / MEASURES / LES MESURES

LONGITUD /LENGTH/ LONGEUR:	9.70 mm
Ø INTERIOR PUNTA/ INSIDE TIP /POINTE INTÉRIEURE:	34.5 mm
Ø INTERIOR BASE / INNER BASE/ FOND INTERIEUR:	40 mm

DESCRIPCIÓN: ANILLO.
MATERIAL: Polipropileno.

DESCRIPTION: RING.
MATERIAL: Polypropylene.

LA DESCRIPTION: BAGUE.
MATÉRIEL: Polypropylène.

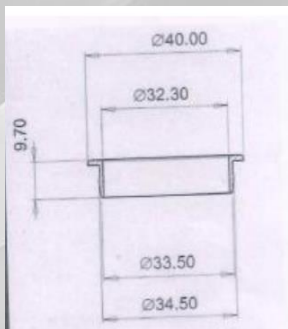

LONGITUD
9.70 mm

Ø I.P 40 mm

OTRAS FORMAS

COLORES REPRESENTATIVOS



REF. 9130

DISTINTIVO PARA TUBO ENCAJABLE 5 GR.



DESCRIPCIÓN: Distintivo para tubo encajable 5 gr.
MATERIAL: Polipropileno.

DESCRIPTION: Badge for nestable tube.
MATERIAL: Polypropylene.

LA DESCRIPTION: Badge pour tube emboîtable
MATÉRIEL: Polypropylène.

REF. 9149

SEPARADOR DE TINTURA ONDULADO

DESCRIPCIÓN: Distintivo para tubo encajable 5 gr.
MATERIAL: Polipropileno.

DESCRIPTION: Wavy dye separator.
MATERIAL: Polypropylene.

LA DESCRIPTION: Séparateur de teinture ondulée.
MATÉRIEL: Polypropylène.



REF. 9120

SEPARADOR DE TINTURA



DESCRIPCIÓN: Separador de tintura.
MATERIAL: Polipropileno.

DESCRIPTION: Dye separator.
MATERIAL: Polypropylene.

LA DESCRIPTION: Séparateur de colorant.
MATÉRIEL: Polypropylène.

OTRAS FORMAS

COLORES
REPRESENTATIVOS



REF. 9160

TAPA PARA TUBO D-69

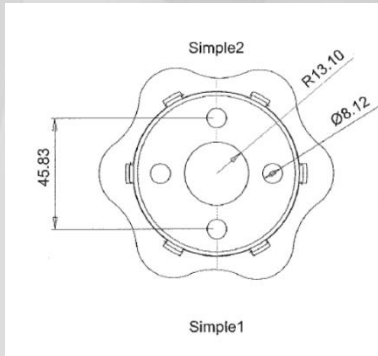

DESCRIPCIÓN: Tapa para tubo D-69.
MATERIAL: Polipropileno.

DESCRIPTION: Cover for tube D-69.
MATERIAL: Polypropylene.

LA DESCRIPTION: Couvercle pour tube D-69.
MATÉRIEL: Polypropylène.

OTRAS FORMAS

REF. 9973

CENTRADOR DOBLE PARA TUBO D110



DESCRIPCIÓN: Centrador doble para tubo D110
MATERIAL: Polipropileno.

DESCRIPTION: Double centerer for tube D110.
MATERIAL: Polypropylene.

LA DESCRIPTION: Centre double pour tube D110.
MATÉRIEL: Polypropylène.

COLORES
REPRESENTATIVOS



REF. 9977

CENTRADOR SENCILLO PARA TUBO D110



DESCRIPCIÓN: Centrador sencillo para tubo d110.
MATERIAL: Polipropileno.

DESCRIPTION: Simple center for tube d110.
MATERIAL: Polypropylene.

LA DESCRIPTION: Centre simple pour tube d110
MATÉRIEL: Polypropylène.

OTRAS FORMAS

COLORES
REPRESENTATIVOS

REF. 9978

CENTRADOR DOBLE PARA TUBO D110



DESCRIPCIÓN: Centrador doble para tubo d110
MATERIAL: Polipropileno.

DESCRIPTION: Double center for tube d110.
MATERIAL: Polypropylene.

LA DESCRIPTION: Centre double pour tube d110
MATÉRIEL: Polypropylène.

Amarillo

Rosa 5

Turquesa

Azul 4

Azul 12

Azul 34

Tabaco

Violeta

Rojo

Verde 9

Verde 10

Verde bandera

Café

Gris claro

Gris

Blanco

Negro





TRIPLASSA
desde 1966

MULTIPLÁSTICOS INYECTADOS S.L.

